





**DONNÉES ÉLECTRIQUES - ELECTRICAL DATA - ELEKTRISCH DATEN
DATOS ELÉCTRICOS - DATI ELETTRICI
ЭЛЕКТРИЧЕСКИЕ ХАРАКТЕРИСТИКИ**







Tecumseh

Représentation des câblages | Wiring annotation | Darstellung der Verkabelung | Representación del cableado |
 Rappresentazione del cablaggio | Обозначение электропроводки

Désignation Designation Bezeichnung Designación Designazione Описание	Signification Description Bedeutung Significado Significato Значение	Représentation Representation Zeichen Representación Rappresentazione Обозначение
Trait continu Solid line Durchgängige Linie Trazo continuo Tratto continuo Сплошная линия	Conducteurs connectés par Tecumseh Europe Wiring connected by Tecumseh Europe Werkseitige Verkabelung von Tecumseh Europe Cableado efectuado por Tecumseh Europe Conduttore connesso da Tecumseh Europe Электропроводка, собранная Т.Е	
Trait interrompu Broken line Punktlinie Trazo discontinuo Tratto interrotto Пунктирная линия	Câblage à réaliser ou suggéré au client, composant à monter ou suggéré au client Customer wiring, actual or suggested. Suggested component to be fitted by the customer Bauseitige Verkabelung Cableado a realizar por ó sugerido al cliente. Componente a montar por ó sugerido al cliente Cablaggio da realizzare dove suggerito o a discrezione del cliente. Componenti da montare dove suggerito o a discrezione del cliente Рекомендуемая клиенту электропроводка. Рекомендуемые клиенту электрокомпоненты	
Mention "AR" Mention "AR" Hinweis "AR" Mención "AR" Dicitura "AR" Буквы "AR"	A raccorder et intégrer dans le schéma global de l'installation To be connected into the wiring of the installation Ist dem Gesamtschaltplan hinzuzufügen oder zu integrieren A conectar e integrar en el esquema global de la instalación Da raccordare e integrare nello schema globale dell'installazione Собрать и включить в общую электросхему оборудования.	AR
Mention "RD" Mention "RD" Hinweis "RD" Mención "RD" Menzione "RD" Буквы "RD"	Peut être utilisé pour un repère de défaut Can be used for a reference for a fault Optional zu Fehlermeldung Puede utilizarse para localizar un defecto Può essere utilizzato per un riferimento di difetto Возможные соединения для обнаружения неисправностей	RD
Mention "AD" Mention "AD" Hinweis "AD" Mención "AD" Menzione "AD" Буквы "AD"	A raccorder en option Connect as an option Optionale Anschlussmöglichkeit Conexionado opcional Da raccordare in opzione Возможные исполнения	AD

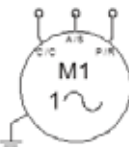
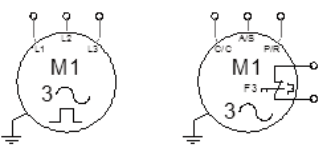
Représentation des éléments | Symbol annotation | Darstellung der Elemente | Representación de los elementos |
 Rappresentazione degli elementi | Обозначение электрокомпонентов

Désignation Designation Bezeichnung Designación Designazione Описание	Représentation Representation Zeichen Representación Rappresentazione Обозначение	Repère Reference Zeichen Señalización Riferimento Знак
Alimentation client Customer supply Stromanschluß bauseits Alimentación cliente Alimentazione cliente Электропитание		
Bornier boîtier Junior Junior electrical connection box Anschlussklemmleiste Schaltkasten Junior Regleta caja eléctrica junior Morsettiera boîtier junior Электровыводы коробки Junior		BNJ
Compresseur Monophasé Single phase compressor Wechselstrom-Verdichter Compresor monofásico Compressore Monofase Монофазный компрессор		Mx Rmq : Noms des phases C/C : Commun/Commun - A/S : Auxiliaire/Start - P/R : Principale/Run Rmq : Name of phases C/C : Commun / Commun, A/S : Auxiliaire / Start, P/R : Principale / Run Anm. : Phasenbezeichnung C/C : gemeinsame Phase, A/S : Hilfswicklung, P/R : Hauptwicklung Obs : Nombre fases C/C : Común/Común, A/S : Auxiliari/Arranque, P/R : Principal/Marcha Rmq : Nome delle fasi C/C : Comune/ Comune, A/S : Ausiliario / Start, P/R : Principale / Run название обмоток C/C : общая обмотка A/S : пусковая обмотка P/R : рабочая обмотка
Compresseur Triphasé Three phase compressor Drehstrom-Verdichter Compresor trifásico Compressore Trifase Трёхфазный компрессор		Mx
Bornier Bornier Klemmen Regleta Morsettiera Клеммы		



Désignation - Designation Bezeichnung - Designación Designazione Описание	Représentation - Representation Zeichen - Representación Rappresentazione Обозначение	Repère - Reference Zeichen - Señalización Riferimento Знак
Ventilateur - Fan Ventilator - Ventilador Ventilatore ВЕНТИЛЯТОР		Mx
Protecteur thermique - Thermal protector Thermischer Motorschutzschalter Protector térmico - Protettore termico Тепловое реле	F1	Fx
Relais de démarrage intensité - I: Current relay Stromabhängiges Anlaufrelais - Relé de arranque (intensidad) Relé di spunto di intensità Пусковое реле тока		I
Relais de démarrage de tension - U: Potential relay Spannungsabhängiges Anlaufrelais Relé de arranque (tensión) - Relé di spunto di tensione Пусковое реле напряжения		U
Pressostat HP/BP de sécurité réarmement automatique HP/LP pressure switch auto re-set Hoch- / Niederdruckschalter mit automatischer Rückstellung Presostato de seguridad HP/ BP con rearme automático Pressostato HP BP di sicurezza a riarmamento automatico Автоматическое реле высокого и низкого давления		LP HP
Lampe - Lamp Lampe - Luz piloto Lampada Лампочка		
Condensateur de démarrage - Condensateur permanent Start capacitor - Run Capacitor Anlaufkondensator - Betriebskondensator Condensador de arranque - Condensador permanente Condensatore di spunto - Condensatore permanente Пусковой конденсатор - Рабочий конденсатор		Cdx Cpx
Condensateur avec résistance de décharge Capacitor with discharge resistor Kondensator mit Entladungswiderstand Condensador con resistencia de descarga Condensatore con resistenza di scarico Конденсатор с разрядным сопротивлением	Cd	Cdx
Réchauffeur de carter - A CTP : sans raccordement de terre Réchauffeur de carter - A résistance : avec raccordement terre Crankcase heater PTC: Without earth connection Crankcase heater - Resistance with earth connection Kurbelwannenheizung CTP: ohne Erdungsanschluß Kurbelwannenheizung - Widerstandsheizung : mit Erdungsanschluß Calentador de cárter Por CTP : sin conexión a tierra Calentador de cárter - Por Resistencia : con conexión a tierra Resistenza del carter A CTP : senza collegamento di terra Resistenza del carter - A Resistenza : con collegamento di terra Картерный подогреватель С резистором без заземления С сопротивлением без заземления	R1	Rx
Ensemble disjoncteur magnétothermique/Contacteur Circuit breaker / contactor assembly Einheit : thermomagnetischer Überlastschalter / Schaltzchütz Contactor y disyuntor magnetotérmico Interruttore magnetotermico/contattore Узел тепловой выключатель/ Контактор		Dx KMx
Variateur de vitesse - Fan speed control Drehzahlregler - Variador de velocidad Variatore di velocità Регулятор скорости вращения вентилятора		P
Sectionneur - Isolator Seccionador - Sezionatore Переключатель		Dx
Disjoncteur magnétothermique ventilateur EC Fan Circuit breaker Disyuntor magnetotérmico del ventilador Interruttore magnetotermico ventilatore Тепловой выключатель вентилятора		Dx

SILAJ2432ZFZ
 SILAJ2440ZFZ
 SILAJ2446ZFZ
 SILAJ2464ZFZ
 SILAE9450ZFZ
 SILAE9460ZFZ
 SILAJ9480ZFZ
 SILAJ9510ZFZ
 SILAJ9513ZFZ
 SILAJ4511YFZ
 SILRG2426ZFZ
 SILRG2432ZFZ
 SILRG2436ZFZ
 SILRG2446ZFZ
 SILRG4467ZFZ
 SILRG4480ZFZ
 SILRG4492ZFZ
 SILRG4512ZFZ

220-240V - 1~ - 50 Hz

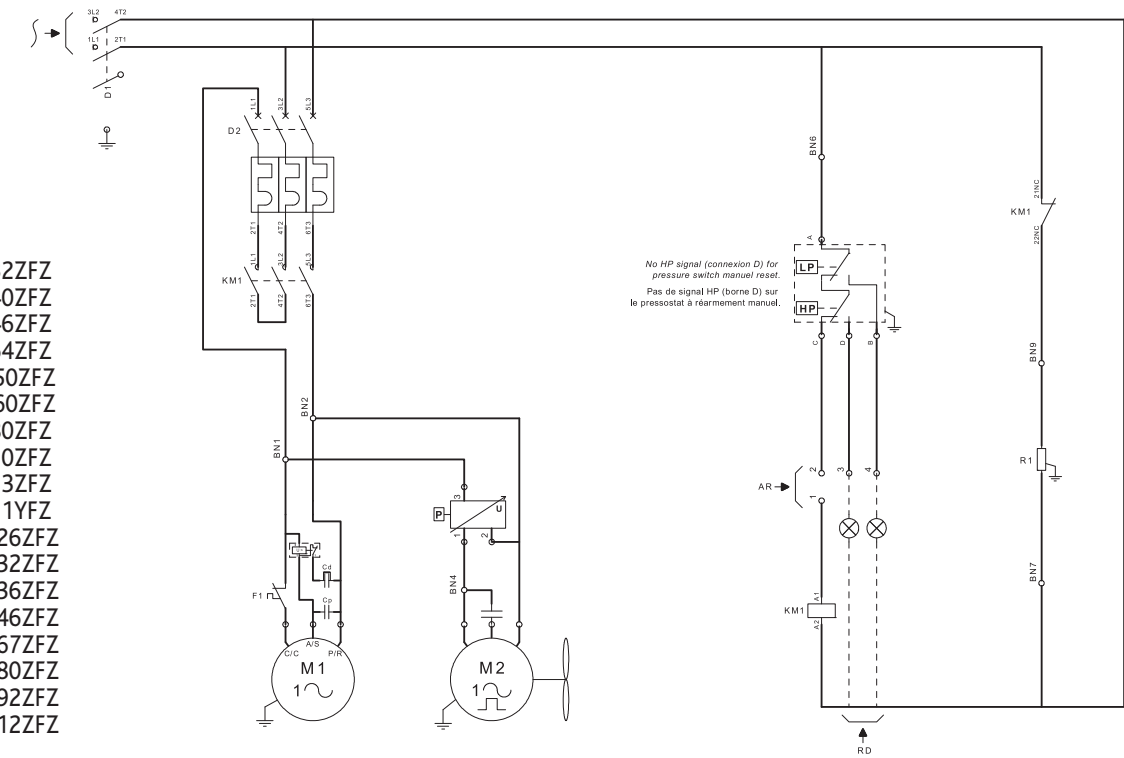

SILAE4440YFZ
 SILAJ4461YFZ
 SILAJ4476YFZ
 SILAJ4492YFZ
 SILRG4445YFZ
 SILRG4450YFZ
 SILRG4460YFZ
 SILRG4476YFZ

220-240V - 1~ - 50 Hz

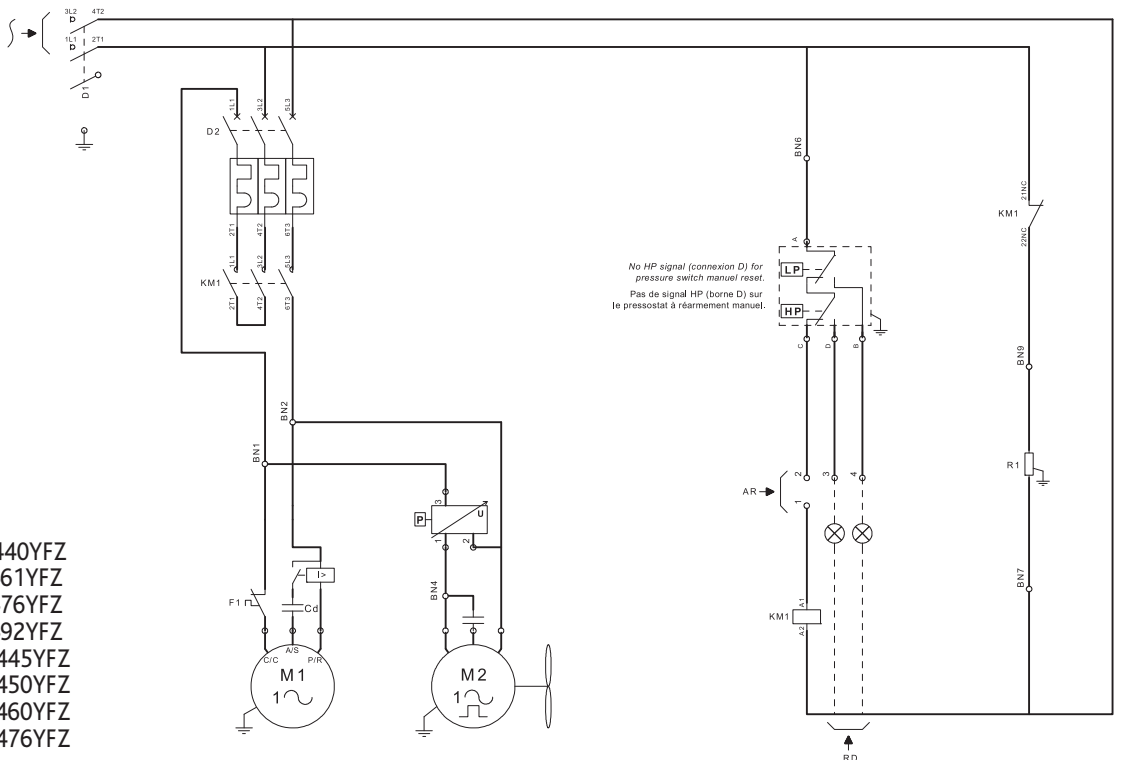

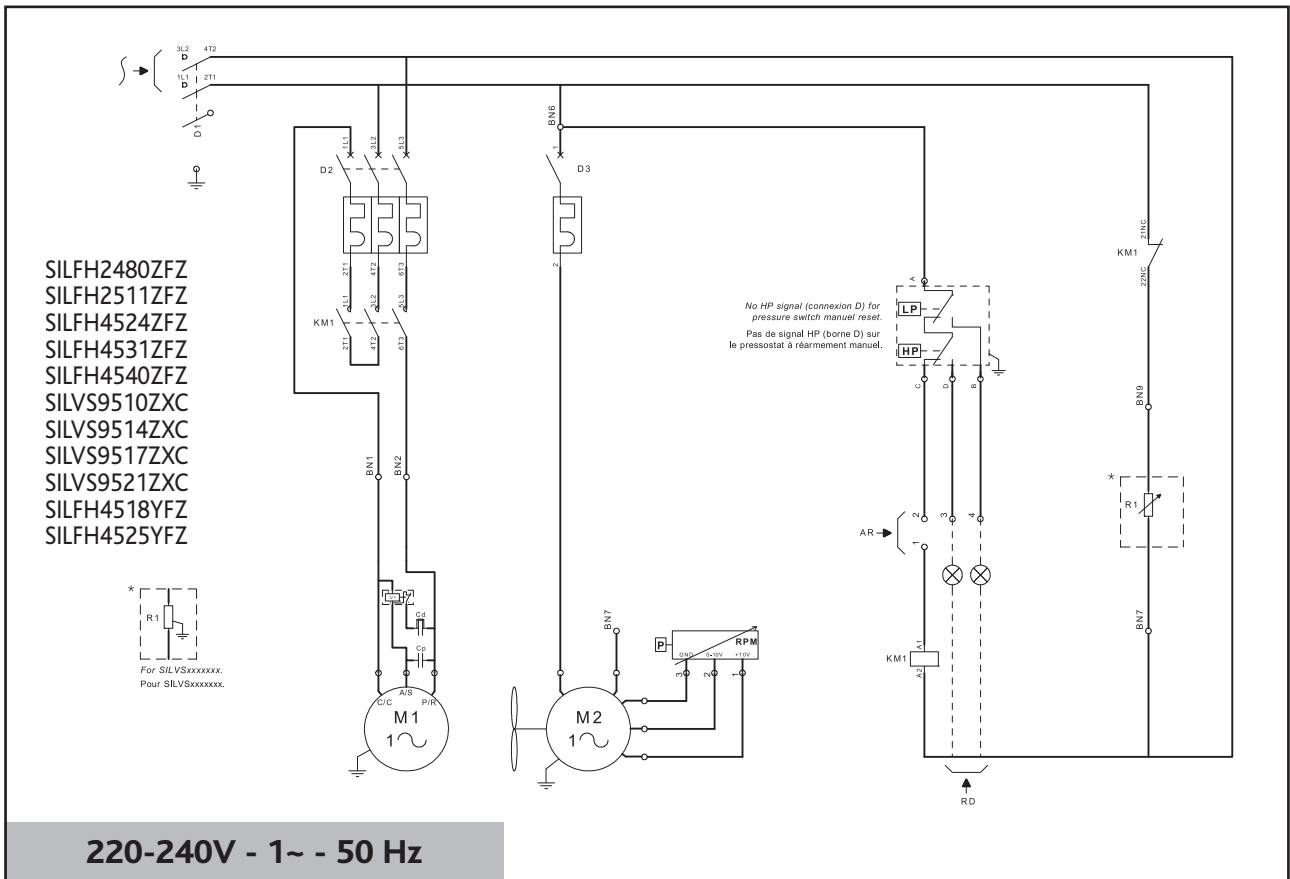
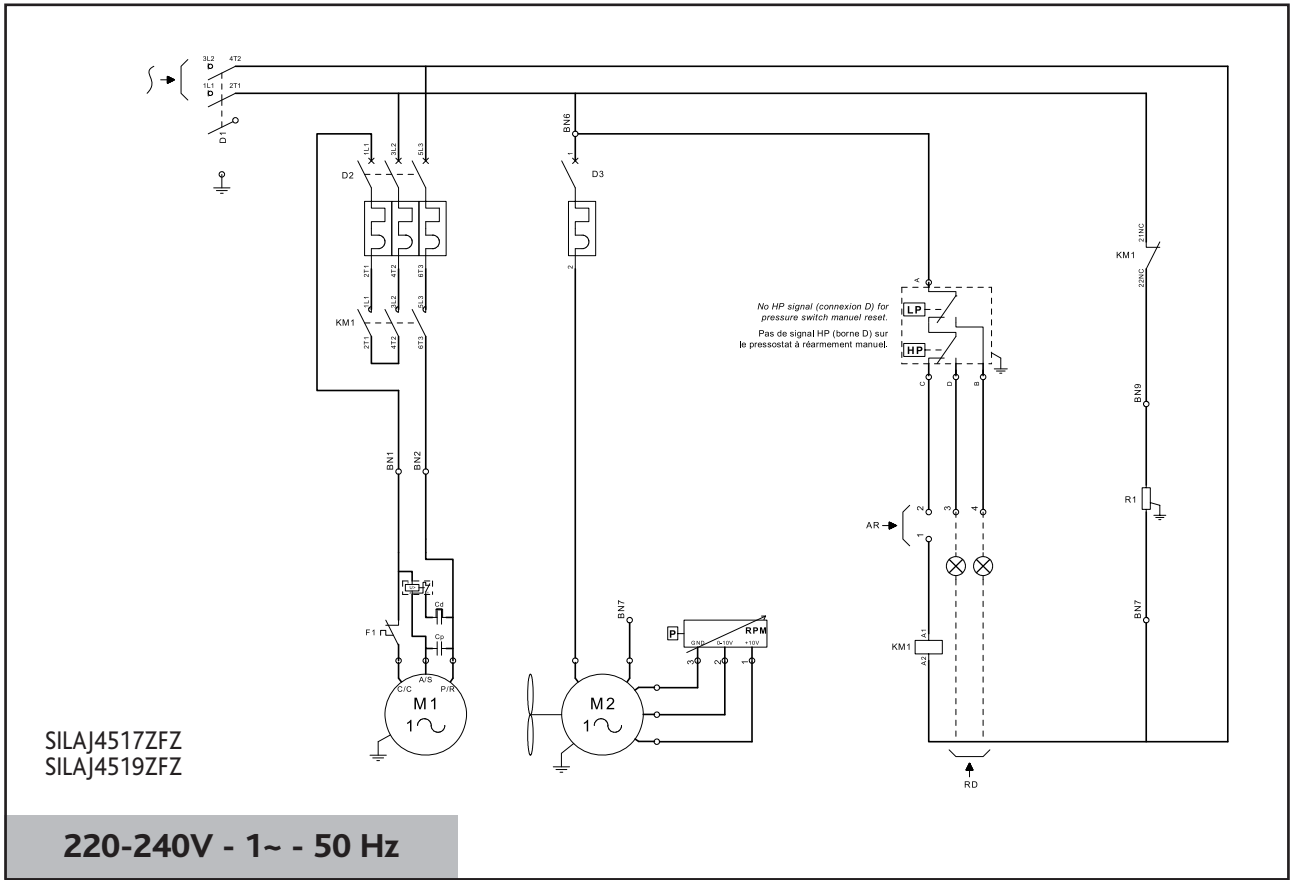

SILAJ2432ZTZ
 SILAJ2446ZTZ
 SILAJ2464ZTZ
 SILAJ9480ZTZ
 SILAJ9510ZTZ
 SILAJ9513ZTZ
 SILAJ4461Y TZ
 SILAJ4492Y TZ
 SILAJ4511Y TZ

400/440V - 3N~ - 50/60 Hz

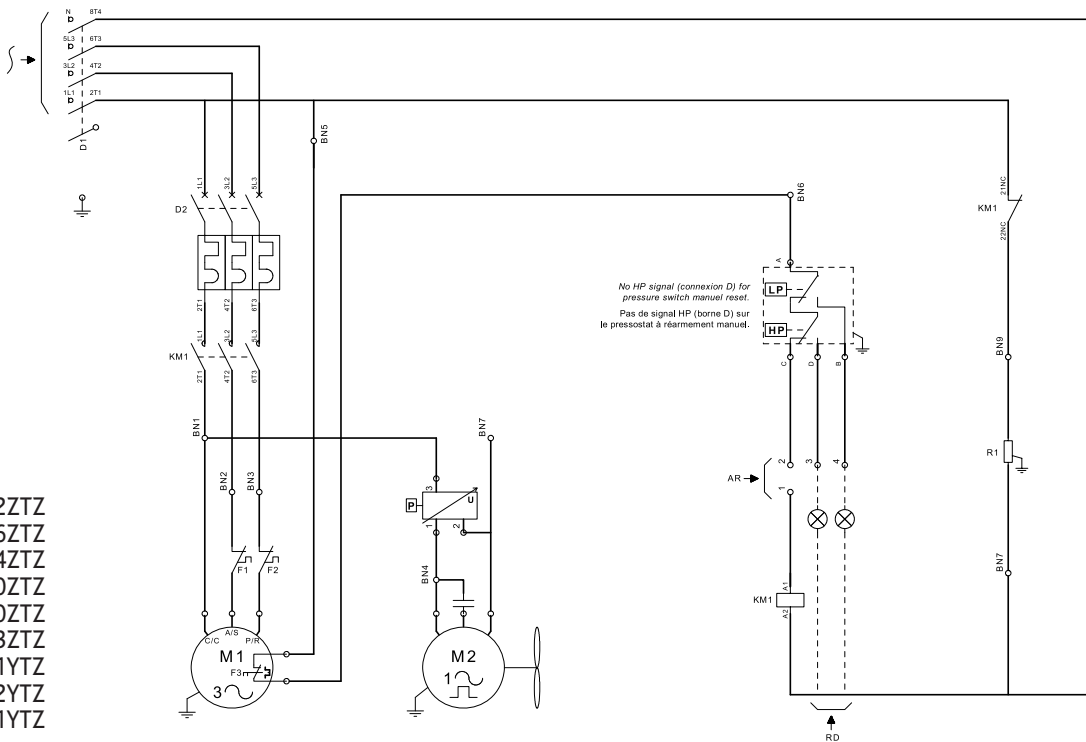

SILAJ4517ZTZ
 SILAJ4519ZTZ

400/440V - 3N~ - 50/60 Hz

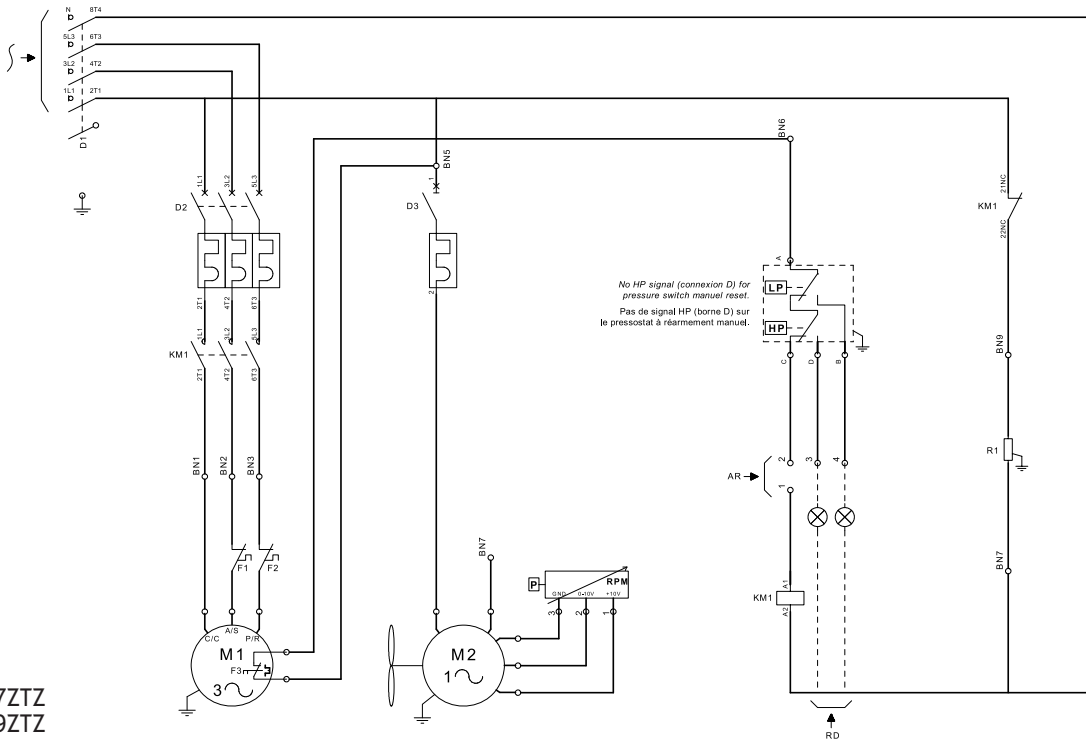

SILFH2480ZTZ
 SILFH2511ZTZ
 SILFH4524ZTZ
 SILFH4531ZTZ
 SILFH4540ZTZ
 SILVS9510ZXG
 SILVS9514ZXG
 SILVS9517ZXG
 SILVS9521ZXG
 SILFH4518YTZ
 SILFH4525YTZ

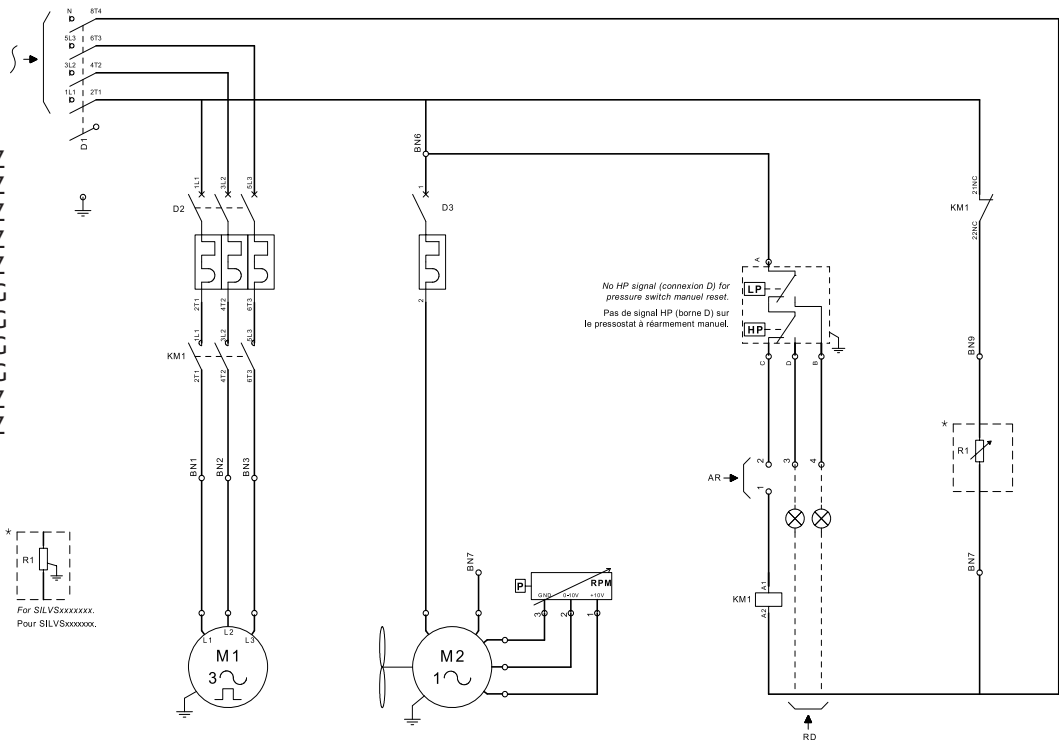

400/440V - 3N~ - 50/60 Hz
380-420/460V - 3N~ - 50/60 Hz

SILAJ4476YKZ
 SILAJ4511YKZ
 SILAJ2446ZKZ
 SILAJ2464ZKZ

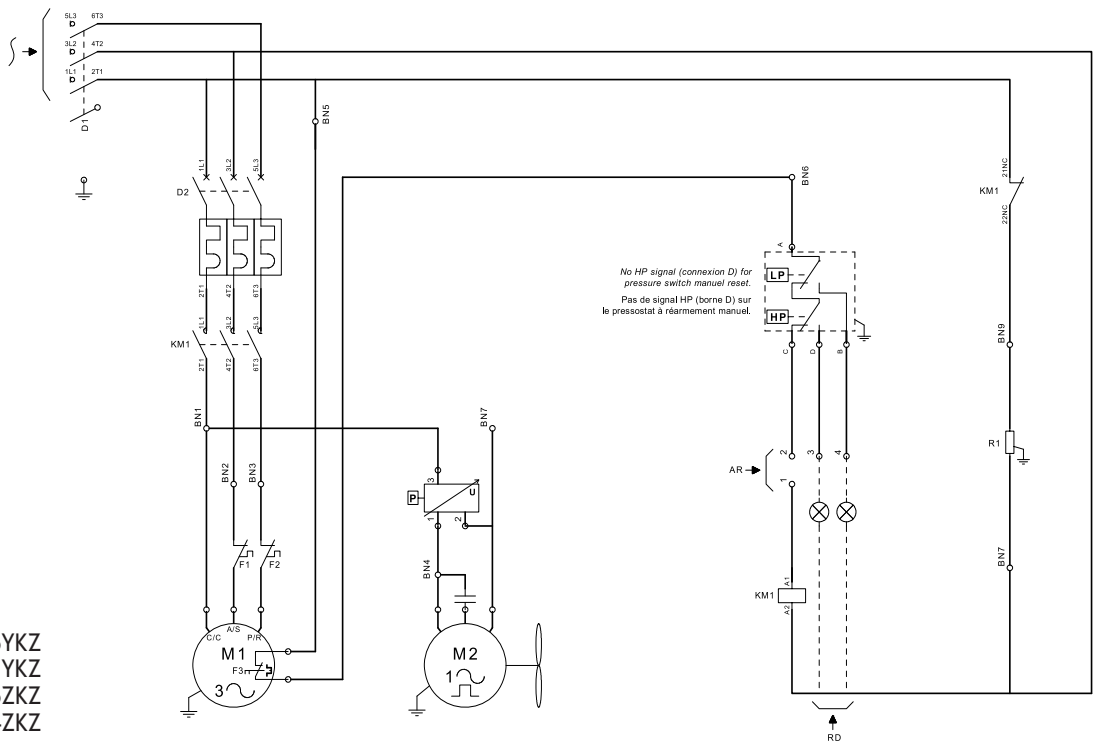

220/220V - 3~ - 50/60 Hz



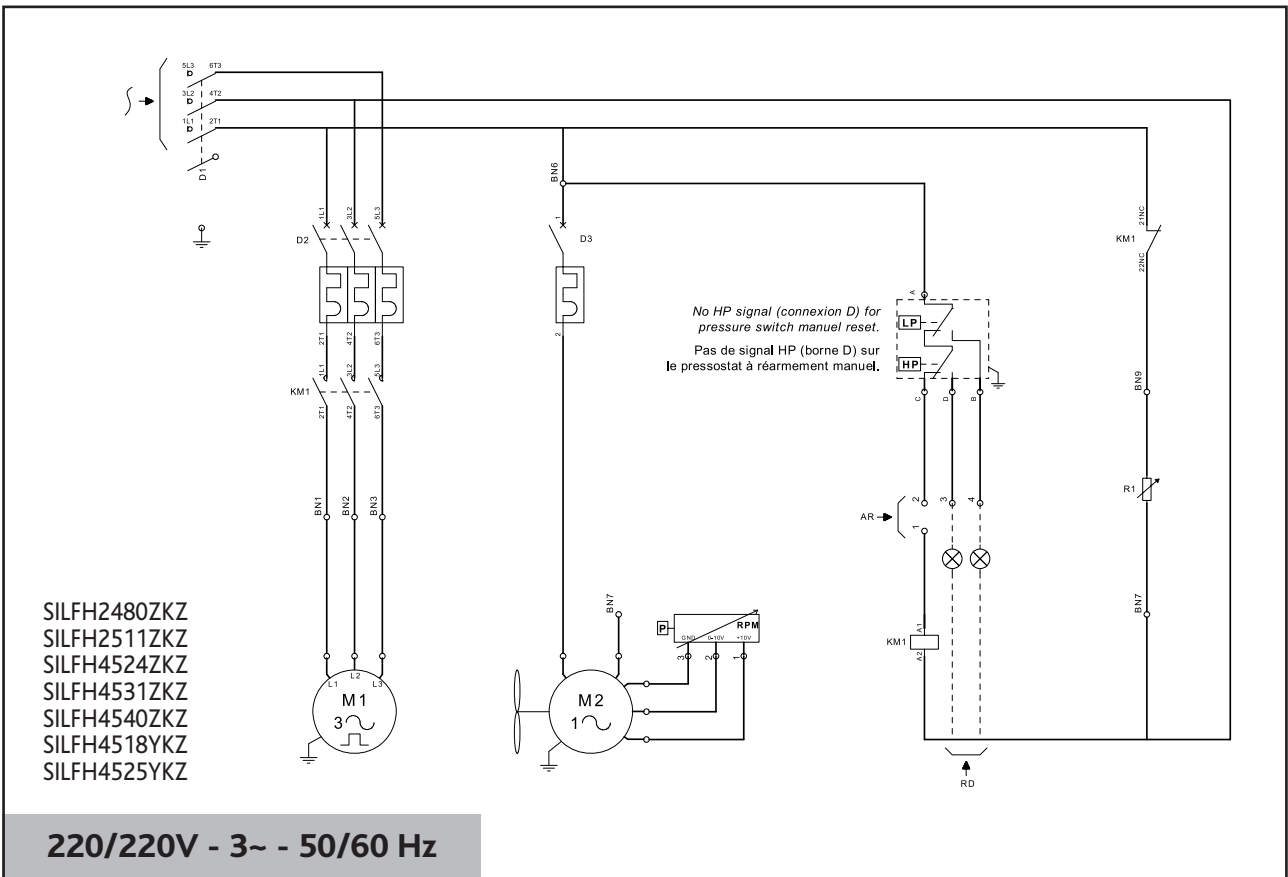
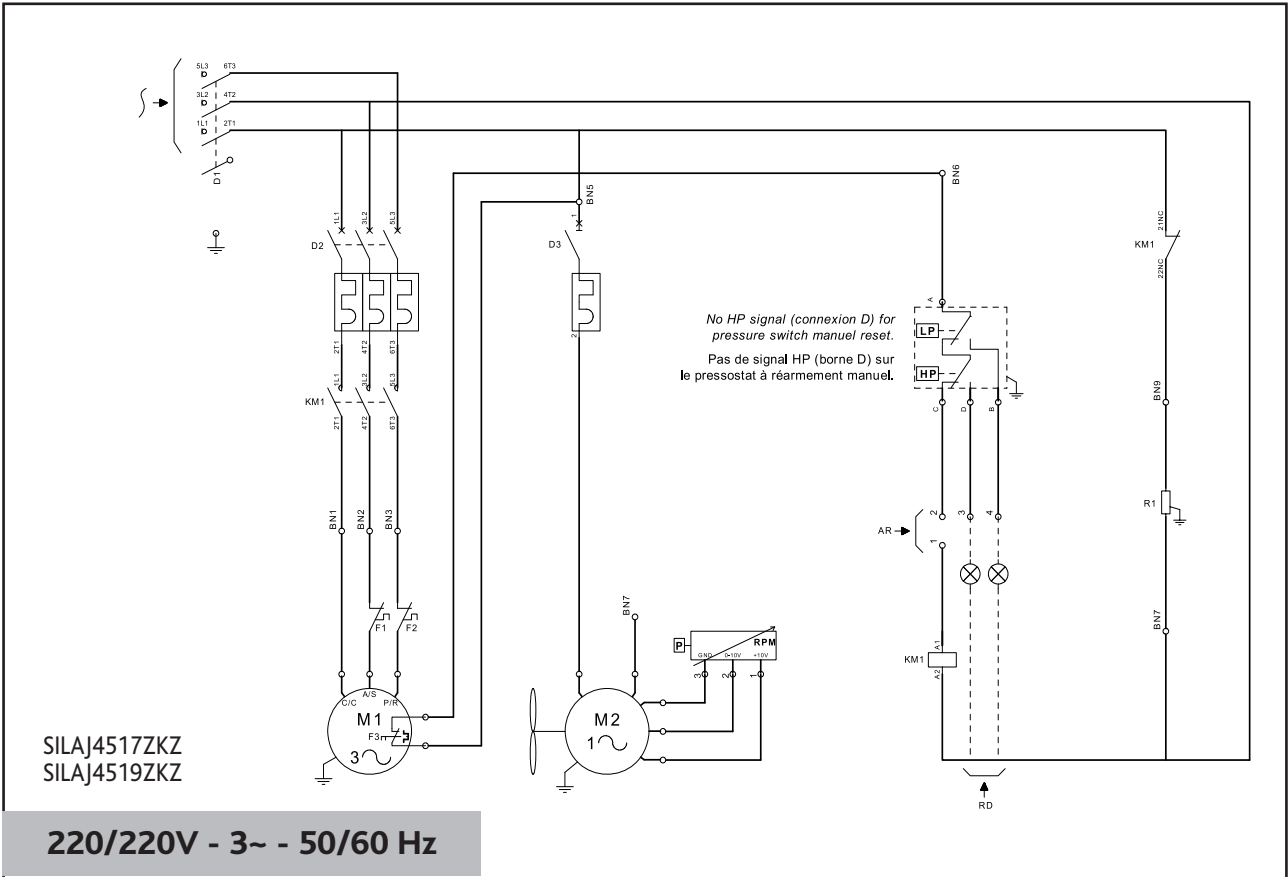

SILAG2516ZTZ
 SILAG2522ZTZ
 SILAG4546ZTZ
 SILAG4553ZTZ
 SILAG4561ZTZ
 SILAG4568ZTZ
 SILAG4573ZTZ
 SILAG4528Y TZ
 SILAG4534Y TZ
 SILAG4537Y TZ
 SILAG4543Y TZ
 SILVS9524ZXG
 SILVS9528ZXG
 SILVS9536ZXG
 SILVS9544ZXG

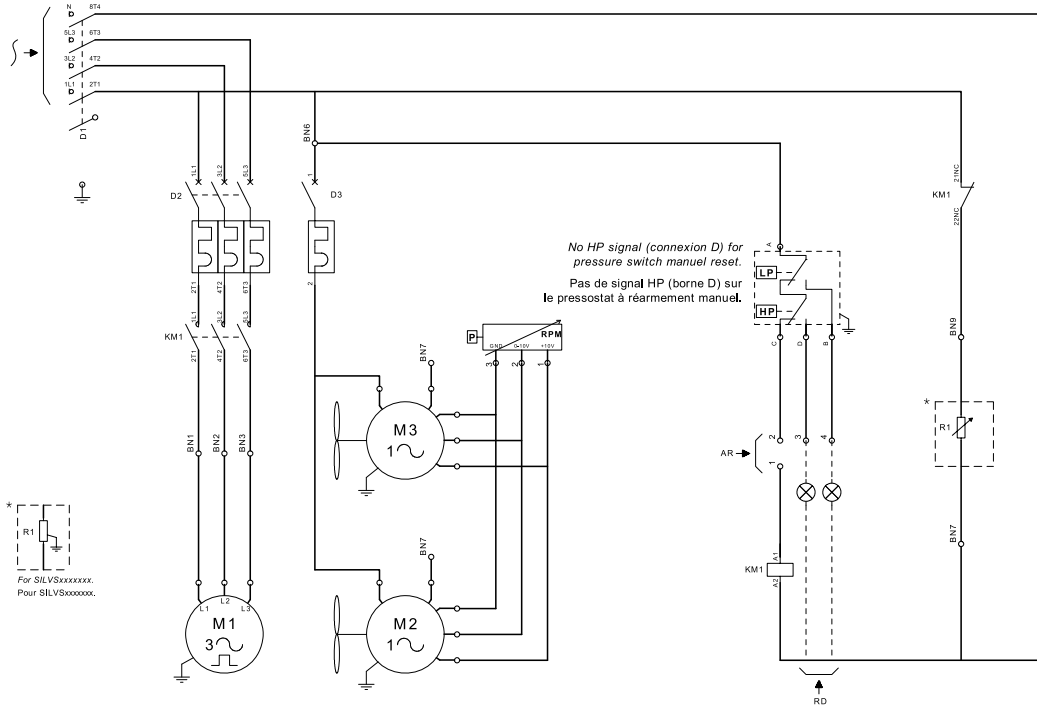

400/440V - 3N~ - 50/60 Hz
380-420/460V - 3N~ - 50/60 Hz

SILAG2516ZKZ
 SILAG2522ZKZ
 SILAG4546ZKZ
 SILAG4553ZKZ
 SILAG4561ZKZ
 SILAG4568ZKZ
 SILAG4573ZKZ
 SILAG4528YKZ
 SILAG4534YKZ
 SILAG4537YKZ
 SILAG4543YKZ

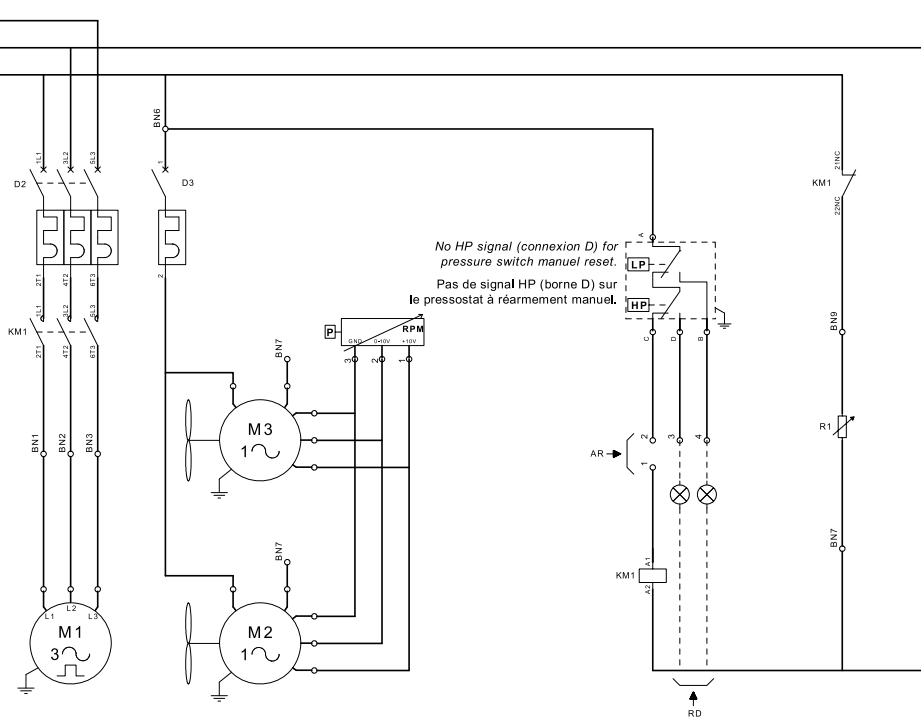

220/220V - 3~ - 50/60 Hz



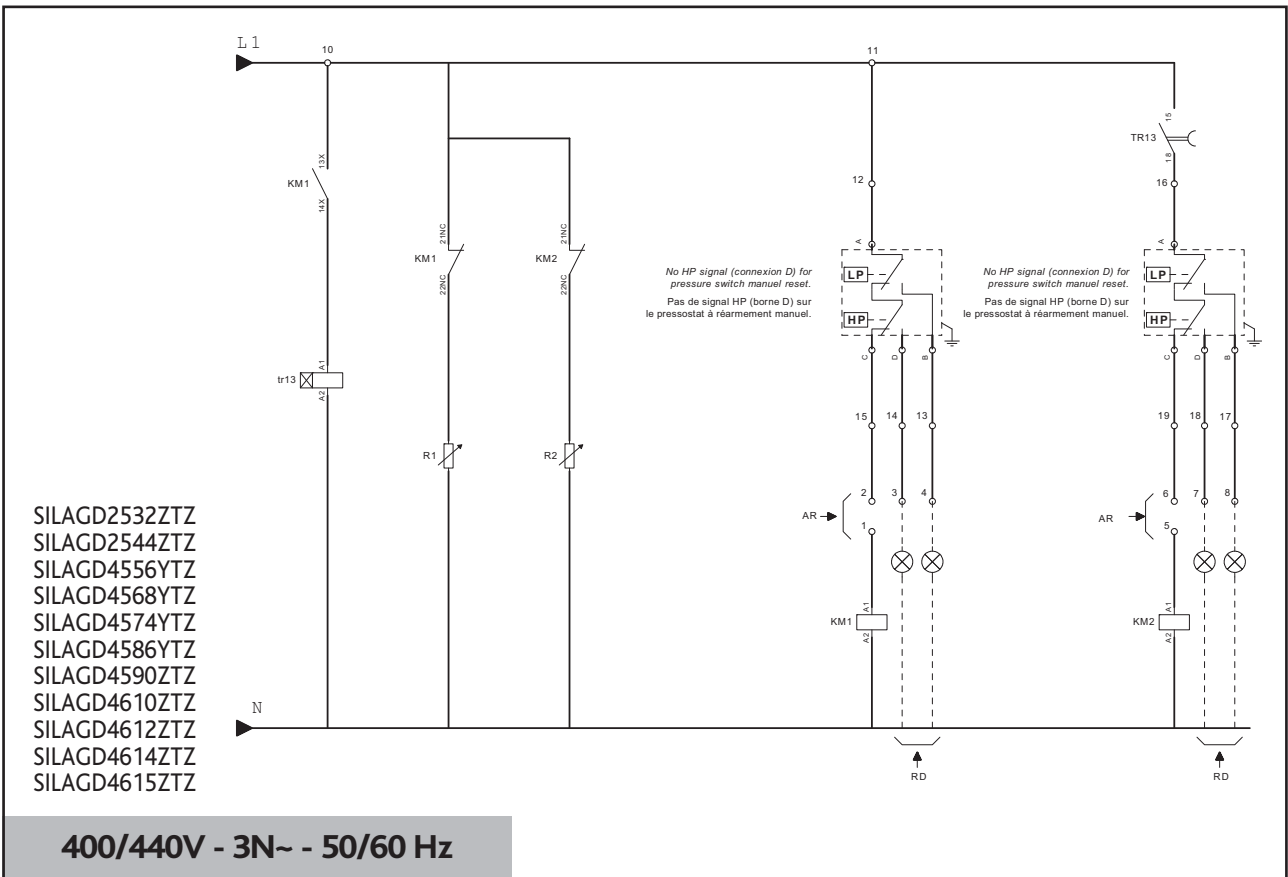
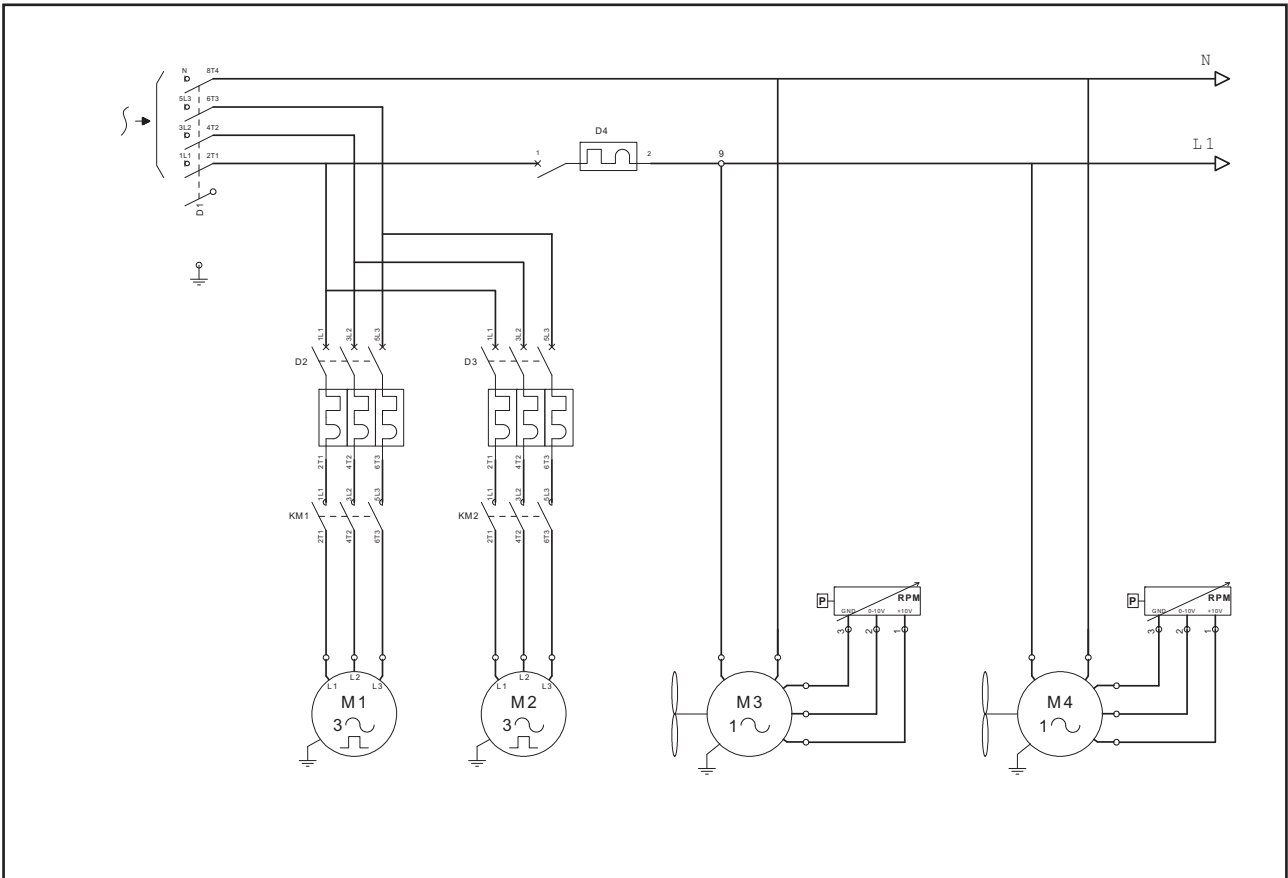

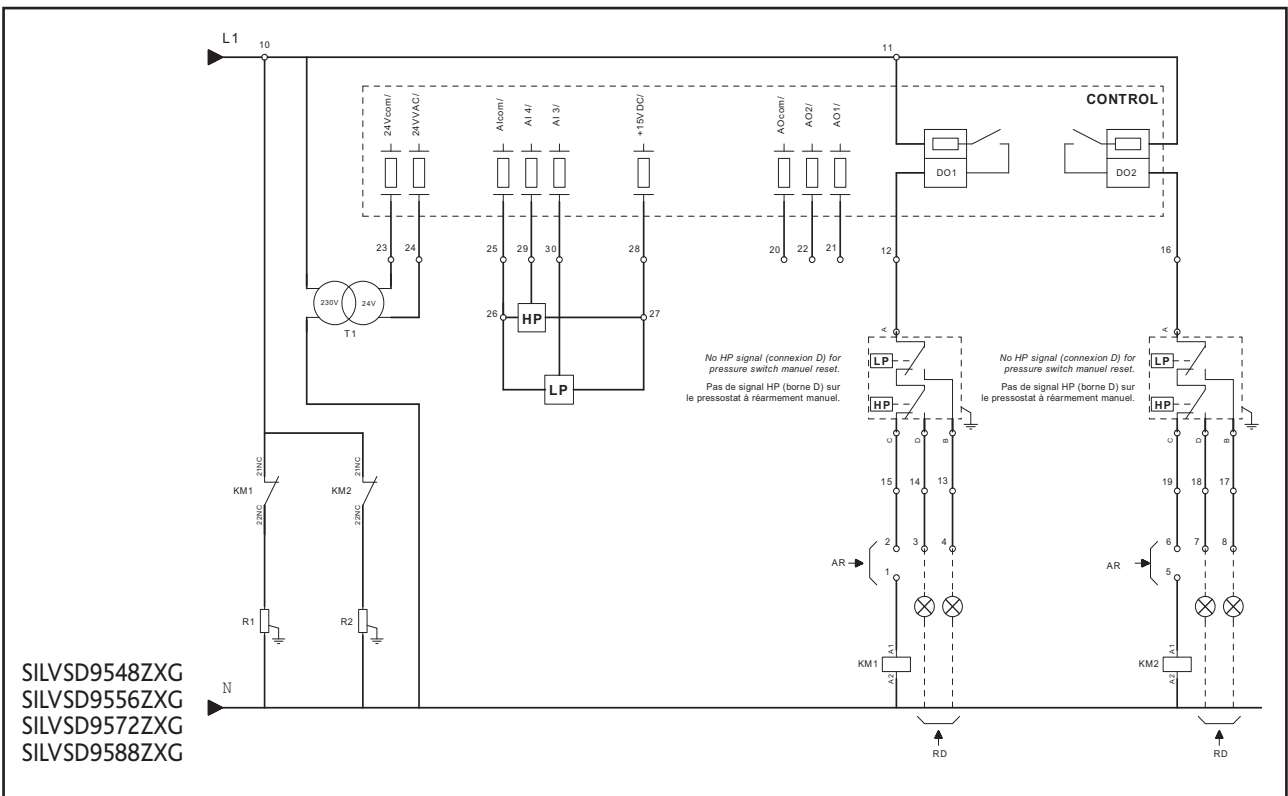
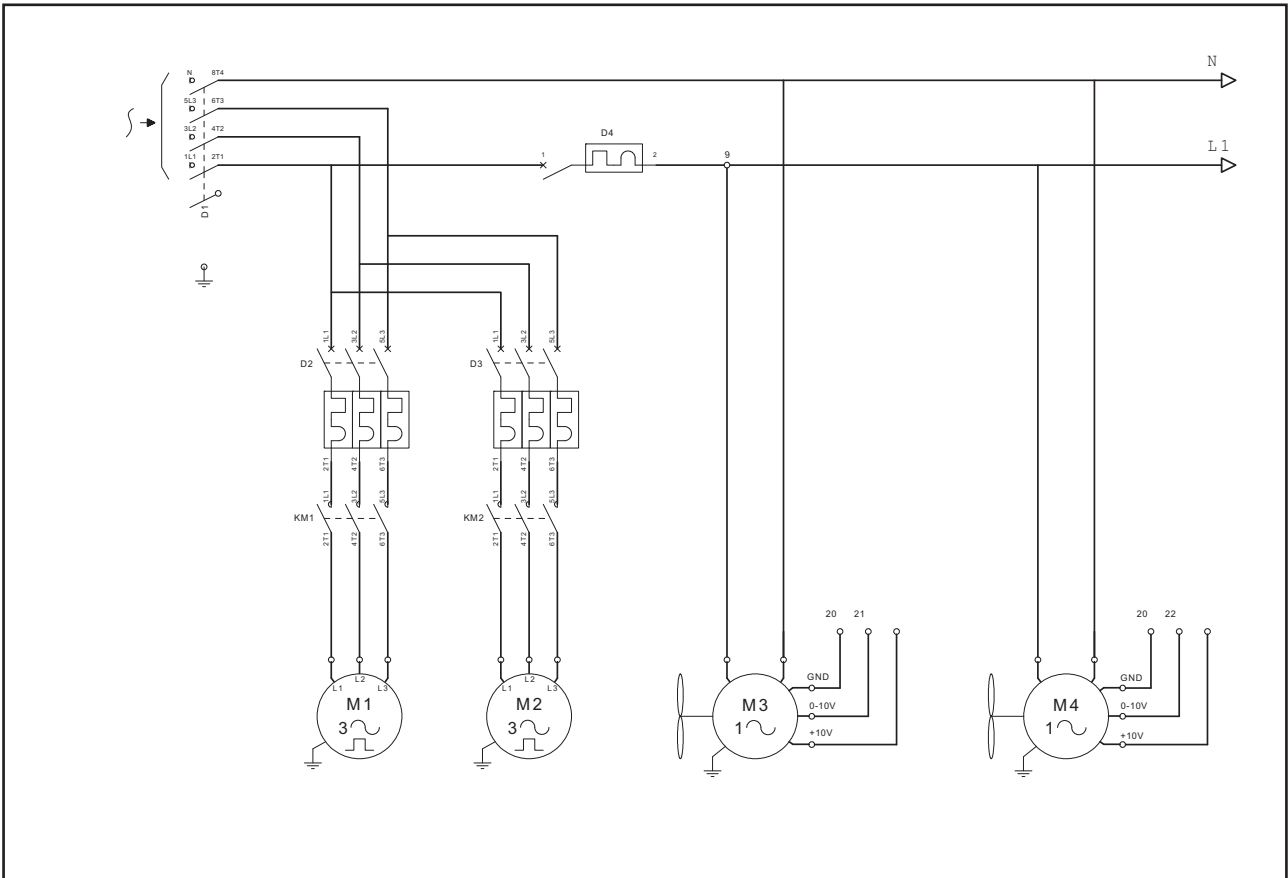

SILVSD9548ZXG
 SILVSD9556ZXG
 SILVSD9572ZXG
 SILVSD9588ZXG

380-420/460V - 3N~ - 50/60 Hz





Taille S



Taille L



Taille M

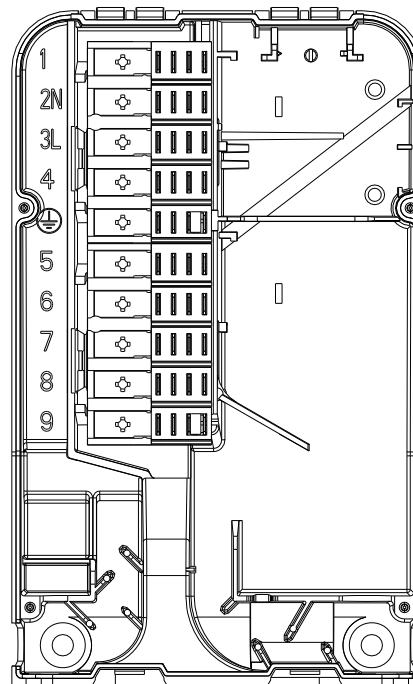
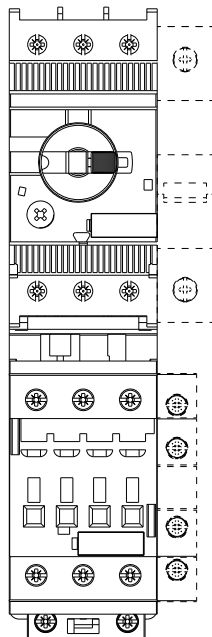
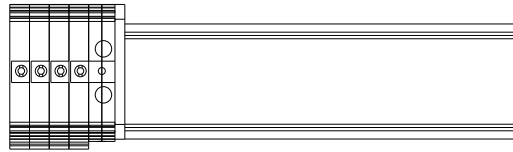
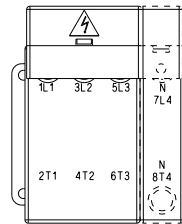



Taille XL

SILAGD ou SILVSD

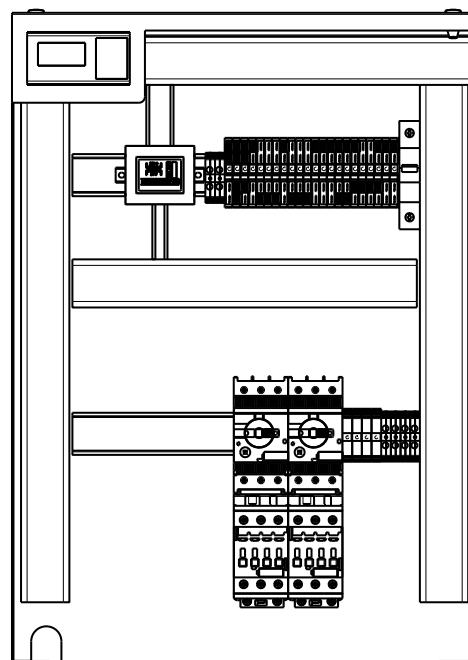
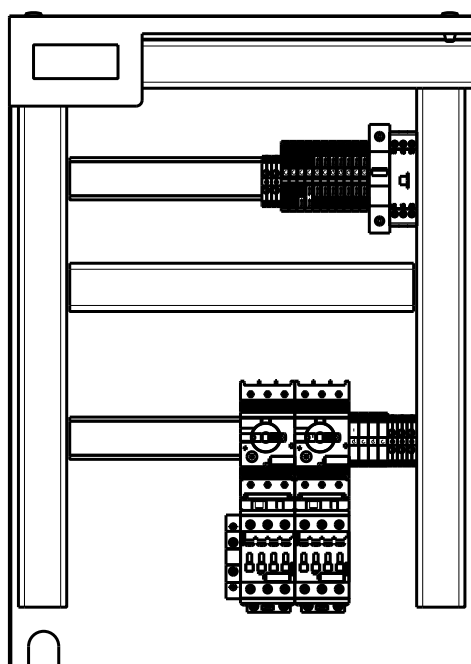

Fluide frigorigène Refrigerant Kältemittel Fluido frigorigeno Fluido frigorigeno Хладагент	Applications Application Anwendung Applicazione оборудование	Modèles Models Modelle Modelli модель	[V]	50 Hz		60 Hz		50 Hz		60 Hz		Indication réglage disjoncteur magnétothermique compressor Adjustment power circuit breaker Angabe zur Einstellung thermomagneti- scher Überlastschalter	
				Nombre de phase Phase Anzahl der Phasen Número e fases Numero di fase число фаз	Intensité nominale compresseur ² Nominal compressor current ² Nominale Stromaufnahme Verdichter ² Intensidad nominal compresor ² Intensità nominale compressore ² номинальный ток компрессора ²	Intensité max compresseur Max. compressor current Maximale Stromaufnahme Verdichter ² Intensidad máxima compresor Intensità massima compressore максимальный ток компрессора	Intensité nominale compresseur ² Nominal compressor current ² Nominale Stromaufnahme Verdichter ² Intensidad nominal compresor ² Intensità nominale compressore ² номинальный ток компрессора ²	Intensité max compresseur Max. compressor current Maximale Stromaufnahme Verdichter ² Intensidad máxima compresor Intensità massima compressore максимальный ток компрессора	Intensité nominale ventilateur Nominal fan current Nominale Stromaufnahme Lüfter Intensidad nominal ventilador Intensità nominale ventilatore номинальный ток вентилятора	Intensité max ventilateur Current, maximum fan current Maximale Stromaufnahme Lüfter Intensidad máxima ventilador Intensità massima ventilatore максимальный ток вентилятора	Intensité nominale ventilateur Nominal fan current Nominale Stromaufnahme Lüfter Intensidad nominal ventilador Intensità nominale ventilatore номинальный ток вентилятора		Intensité max ventilateur Current, maximum fan current Maximale Stromaufnahme Lüfter Intensidad máxima ventilador Intensità massima ventilatore максимальный ток вентилятора
				[A]	[A]	[A]	[A]	[A]	[A]	[A]	[A]		
R-404A	LBP	SILRG2426Z	220-240V	1~	1,9	3,4			0,3	0,5		2,5	
		SILRG2432Z	220-240V	1~	2,4	4,2			0,3	0,5		2,7	
		SILRG2436Z	220-240V	1~	2,6	5			0,3	0,5		2,9	
		SILRG2446Z	220-240V	1~	3,2	5,4			0,3	0,5		4	
		SILAJ2432Z	220-240V	1~	2,5	6,3			0,3	0,5		2,8	
		SILAJ2440Z	220-240V	1~		5,7			0,3	0,5		4	
		SILAJ2446Z	220-240V	1~	3,8	7,9			0,3	0,5		4,1	
		SILAJ2446Z	400/440V	3~	1,5	2,9	1,6	2,8	0,3	0,5	0,3	0,6	1,8
		SILAJ2464Z	220-240V	1~	5,7	10			0,3	0,5		6,3	
		SILAJ2464Z	400/440V	3~	2,2	3,4	2,1	3,3	0,3	0,5	0,3	0,6	2,5
		SILFH2480Z	220-240V	1~	7,2	16			1,1	1,1		8	
		SILFH2480Z	400/440V	3~	2,8	6,3	3	6,4	1,1	1,1	1,1	1,1	4
		SILFH2480Z	220-240V	3~	4,6	10,6	5,4	10,8	1,1	1,1	1,1	1,1	6,3
		SILFH2511Z	220-240V	1~	11,5	24			1,1	1,1		11,5	
		SILFH2511Z	400/440V	3~	3,7	7,2	3,8	7,2	1,1	1,1	1,1	1,1	4
		SILFH2511Z	220-240V	3~	6,5	13,3	7,1	13,4	1,1	1,1	1,1	1,1	8
		SILAG2516Z	220-240V	3~	8,7	24,7	10	24,6	1,1	1,1	1,1	1,1	10
		SILAG2516Z	400/440V	3~	4,6	9,8	5,3	10,6	1,1	1,1	1,1	1,1	6,3
		SILAG2522Z	220-240V	3~	11,5	29,5	12,9	30,9	1,1	1,1	1,1	1,1	16
		SILAG2522Z	400/440V	3~	6,1	12,5	6,7	12,5	1,1	1,1	1,1	1,1	6,3
	SILAGD2532Z	220-240V	3~	8,7	24,7	10	24,6	1,2	1,2	1,2	1,2	10	
	SILAGD2532Z	400/440V	3~	4,6	9,8	5,3	10,6	1,2	1,2	1,2	1,2	6,3	
	SILAGD2544Z	220-240V	3~	11,5	29,5	12,9	30,9	1,2	1,2	1,2	1,2	16	
	SILAGD2544Z	400/440V	3~	6,1	12,5	6,7	12,5	1,2	1,2	1,2	1,2	6,3	
	SILVS9510Z	220-240V	1~	8	14,7			1,1	1,1		8		
	SILVS9510Z	400/440V	3~	2,9	4,6	2,9	4,8	1,1	1,1	1,1	1,1	4	
	SILVS9514Z	220-240V	1~	11,6	23,4			1,1	1,1		11,6		
	SILVS9514Z	400/440V	3~	4,2	6	4,1	6,5	1,1	1,1	1,1	1,1	4,2	
	SILVS9517Z	220-240V	1~	13	22,6			1,1	1,1		13		
	SILVS9517Z	400/440V	3~	4,7	6,6	4,5	6,9	1,1	1,1	1,1	1,1	6,3	
	SILVS9521Z	220-240V	1~	16,3	26,7			1,1	1,1		16,3		
	SILVS9521Z	400/440V	3~	5,4	8,8	5,4	9,4	1,1	1,1	1,1	1,1	6,3	
	SILVS9524Z	400/440V	3~	5,7	9,2	5,9	9,5	1,1	1,1	1,1	1,1	6,3	
	SILVS9528Z	400/440V	3~	7,3	12,5	7,5	15,1	1,1	1,1	1,1	1,1	8	
	SILVS9536Z	400/440V	3~	9,2	14,7	9	14,2	1,1	1,1	1,1	1,1	10	
	SILVS9544Z	400/440V	3~	11,3	19,3	11,3	20,2	1,1	1,1	1,1	1,1	11,3	
	SILVSD9548Z	400/440V	3~	5,7	9,2	5,9	9,5	1,2	1,2	1,2	1,2	6,3	
	SILVSD9556Z	400/440V	3~	7,3	12,5	7,5	15,1	1,2	1,2	1,2	1,2	8	
	SILVSD9572Z	400/440V	3~	9,2	14,7	9	14,2	1,2	1,2	1,2	1,2	10	
	SILVSD9588Z	400/440V	3~	11,3	19,3	11,3	20,2	1,2	1,2	1,2	1,2	11,3	
	SILAE9450Z	220-240V	1~	2,8	3,9			0,3	0,5		4		
	SILAE9460Z	220-240V	1~	3,4	5,2			0,3	0,5		4		
	SILRG4467Z	220-240V	1~	2,6	4,5			0,3	0,5		2,9		
	SILRG4480Z	220-240V	1~	3,3	5,3			0,3	0,5		4		
	SILRG4492Z	220-240V	1~	3,5	5,9			0,3	0,5		4		
	SILRG4512Z	220-240V	1~	4,5	6,7			0,3	0,5		4,8		
	SILAJ9480Z	220-240V	1~	4,3	6,7			0,3	0,5		4,6		
	SILAJ9480Z	400/440V	3~	1,8	3	1,8	2,9	0,3	0,5	0,3	0,6	2,5	
	SILAJ9510Z	220-240V	1~	5,3	8			0,3	0,5		6,3		
	SILAJ9510Z	400/440V	3~	2,1	3	2,2	3	0,3	0,5	0,3	0,6	2,5	
SILAJ9513Z	220-240V	1~	6,5	10,2			0,3	0,5		6,8			
SILAJ9513Z	400/440V	3~	2,5	3,9	2,7	4,1	0,3	0,5	0,3	0,6	2,8		
SILAJ4517Z	220-240V	1~	7,1	10,6			1,1	1,1		8			
SILAJ4517Z	400/440V	3~	3	4	3	4	1,1	1,1	1,1	1,1	4		
SILAJ4517Z	220-240V	3~	5,3	6	5,8	6,8	1,1	1,1	1,1	1,1	6,3		
SILAJ4519Z	220-240V	1~	9,9	15,2			1,1	1,1		10			
SILAJ4519Z	400/440V	3~	4	4,8	4	4,7	1,1	1,1	1,1	1,1	4		
SILFH4524Z	220-240V	1~	10,7	19,6			1,1	1,1		10,7			
SILFH4524Z	400/440V	3~	4,3	7,7	4,7	7,9	1,1	1,1	1,1	1,1	6,3		
SILFH4524Z	220-240V	3~	7,5	10	9	13	1,1	1,1	1,1	1,1	8		
SILFH4531Z	220-240V	1~	14,1	22,4			1,1	1,1		16			
SILFH4531Z	400/440V	3~	5,3	9	5,7	10,4	1,1	1,1	1,1	1,1	6,3		
SILFH4531Z	220-240V	3~	10,1	13,5	11,1	15,3	1,1	1,1	1,1	1,1	10,1		



SALES AND MARKETING HEAD OFFICE

2, avenue Blaise Pascal
Site Prologis Bât. B
38090 Vaulx-Milieu
France

Tel. int +33 (0)4 74 82 24 00
Fax int +33 (0)4 74 82 24 44

GERMAN OFFICE

Ludwigstrasse 31
60327 Frankfurt am Main
Germany

Tel. int +49 (0)69 971 454-0
Fax int +49 (0)69 724 10 53

ITALIAN OFFICE

Via Parco Abbaziale, 6
10094 Giaveno (TO)
Italia

Tel. int +39 (0)11 937 98 61
Tel. int +39 (0)11 936 37 31
Fax int +39 (0)11 937 83 88

MALAYSIAN OFFICE

N°18 Jalan Sultan Mohamed 4
Selat Klang Utara
42000 Port Klang
Selangor Darul Eshan
Malaysia

Tel. int +60 3 3176 3886
Fax int +60 3 3176 3890

SPANISH OFFICE

C/Corcega 301-303, 2º, 3a
08008 Barcelona
España

Tel. int +34 93 218 5708
Fax int+34 93 218 169

BRITISH OFFICE

8 The Square, Stockley Park,
Uxbridge Middlesex UB11 1FW
United Kingdom

Tel. int +44 (0) 203 008 8565
Fax int +33 (0)4 74 82 24 99
(Sales & Administration France)



Tecumseh