

## User manual for devices from the ULTU series

**ULTU 100 / 400 / 650**

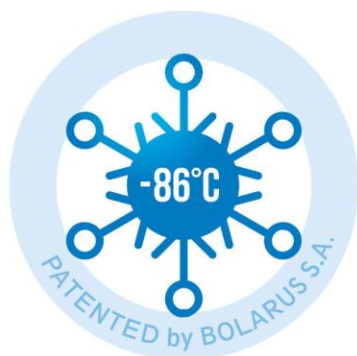

BOLARUS S.A.  
ul. Wiśnicka 12  
32-700 Bochnia, Polska

tel. +48 146 149 300  
sprzedaz@bolarus.com.pl  
www.bolarus.com.pl

|       |   |    |
|-------|---|----|
| 1.    | Information.....  | 3  |
| 1.1.  | General information.....  | 3  |
| 1.2.  | Labels and symbols .....  | 3  |
| 1.3.  | Target group .....  | 4  |
| 2.    | Basic product information .....   | 4  |
| 2.1.  | Designated use of the device .....  | 4  |
| 2.2.  | Compliance.....   | 4  |
| 2.3.  | Further development.....  | 4  |
| 3.    | Safety of use.....  | 4  |
| 3.1.  | Safety instructions for using the device .....  | 5  |
| 3.2.  | Safety instructions for using the device. ....  | 6  |
| 3.3.  | Safety instructions regarding the impact of the environment .....   | 7  |
| 4.    | Symbols used .....  | 7  |
| 5.    | Start-up .....  | 7  |
| 5.1.  | Setting up the device .....   | 8  |
| 5.2.  | Connection to the power grid .....  | 8  |
| 5.3.  | Switching the low-temperature device on and off.....  | 8  |
| 6.    | HMI TOUCH 7 controller user manual: .....   | 9  |
| 6.1.  | Controller specifications.....  | 9  |
| 6.2.  | HMI control panel operation.....  | 10 |
| 6.3.  | Description of the home screen.....   | 11 |
| 6.4.  | Setting the desired temperature.....  | 12 |
| 6.5.  | Temperature graph generation .....  | 13 |
| 6.6.  | Setting the date and time .....   | 14 |
| 6.7.  | Resetting the "Clean condenser" notification .....  | 16 |
|       | The device reminds the user to clean the condenser periodically. The message should be manually reset after the condenser condition check. To reset the message, follow these steps:..... | 16 |
| 6.8.  | List of Alarms .....  | 17 |
| 6.9.  | Alarm clearing .....  | 20 |
| 6.10. | Language setting .....  | 21 |
| 7.    | Assembly and maximum load of shelves .....  | 22 |
| 7.1.  | Shelf assembly .....  | 22 |
| 7.2.  | Maximum standard shelf load.....  | 23 |
| 8.    | Cabinet door handle .....   | 23 |
| 9.    | Exporting data.....   | 23 |
| 10.   | Decompression valves .....  | 26 |
| 10.1. | Automatic decompression valve .....   | 26 |
| 10.2. | Manual decompression valve .....  | 27 |
| 11.   | Access holes.....   | 28 |
| 12.   | Cleaning and maintenance.....   | 29 |
| 12.1. | Cleaning the device's interior and exterior.....  | 29 |
| 12.2. | Maintenance and cleaning of the condenser .....   | 30 |
| 12.3. | Defrosting.....   | 31 |
| 13.   | Practical advice .....  | 31 |
| 14.   | Liabilities and warranties.....   | 31 |
| 15.   | Technical Data .....  | 32 |
| 16.   | Exploded view drawings .....  | 33 |
| 16.1. | ULTU 600 cabinet exploded view drawing .....  | 34 |
| 16.2. | ULTU 400 cabinet exploded view drawing .....  | 36 |
| 16.3. | ULTU 100 cabinet exploded view drawing.....   | 38 |
| 17.   | ULTU 100, 400, 600 wiring diagrams .....  | 40 |
| 17.1. | ULTU 100 wiring diagram .....   | 40 |
| 17.2. | ULTU 400, 600 wiring diagram .....  | 41 |

## 1. Information

This manual contains the necessary information on the installation and operation of Bolarus S.A. low-temperature cabinets. This document provides guidance on environmental conditions, location, operation and maintenance of the device.

### 1.1. General information



#### WARNING

Please read this manual carefully before starting the device. The design of the device ensures that optimum operating parameters are achieved, provided that all the instructions in this manual are followed. To ensure safety, correct operation and the best possible performance, the manufacturer recommends that users learn about the operation, maintenance of the device and basic safety issues. Follow the instructions carefully. This will prevent accidental damage and allow safe use of the device.



#### WARNING

Low-temperature devices require special precautions in terms of electromagnetic compatibility. Please note that the device must be installed and put into operation according to the instructions in the manual.

It is essential to follow the conditions of use and safety instructions described in the manual. This prevents improper use of the device, which can put patients and operators at risk, as well as lead to damage to the device.

**BOLARUS S.A. is not responsible for damage resulting from failure to follow this manual.**

### 1.2. Labels and symbols

In this manual, warnings and special instructions are indicated by the following symbols:

|                    |  |
|--------------------|--|
| <br><b>WARNING</b> | If not observed: danger to persons.  |
| <br><b>CAUTION</b> | If not observed: danger to objects, the device or individual device functions.     |
| <br><b>NOTE</b>    | Additional useful tips and information. (The symbol "i" stands for "information.") |
|                    | Refer to the instructions for use  |

#### NOTE



Symbols representing operating elements as well as device indicators and label symbols are described in Chapter 4 of this manual.

### 1.3. Target group

These Instructions for Use are addressed to:

- qualified laboratory/pharmaceutical personnel
- qualified laboratory technology personnel with appropriate training.



#### **WARNING**

Only persons who meet the above requirements are authorised to use and service the device.

## 2. Basic product information

### 2.1. Designated use of the device

Low-temperature devices are designed to store materials and samples at temperatures from -50 °C to -86 °C. The design of the device ensures that the optimum operating parameters for the type of device are achieved, provided that all the instructions in this manual are followed. To ensure proper operation and the best possible performance, the manufacturer recommends that users learn about the operation, maintenance of the device and basic safety issues. Following the instructions carefully will prevent accidental damage.

Basic features of the device housing.

- it is designed for continuous operation
- corrosion-resistant housing
- stable and roll-over resistant housing
- optionally, it can be fitted with castors (two of which are lockable)

### 2.2. Compliance

The device was designed and manufactured in accordance with the requirements of:

Machinery Directive — 2006/42/EC,  
EMC Directive — 2014/30/EU,  
RoHS Directive — Directive 2011/65/EU  
The device is CE certified.

### 2.3. Further development

BOLARUS S.A. reserves the right to make changes due to technical modifications, product improvements or regulatory changes.

## 3. Safety of use

The device is designed to be operated by adults only and is not intended to be used by persons with limited physical, sensory or mental ability, as well as those with no necessary training. Under no circumstances may children play in the vicinity of a working device, let alone use it for play.



#### **WARNING**

The device is not intended for use by persons with limited physical, sensory or mental abilities (including children).

### 3.1. Safety instructions for using the device

Operate the low-temperature device in a ventilated room within the ambient temperature range:

- low-temperature devices ambient temp. from +16 to +25°C with relative humidity not exceeding 60%,

For the best operating conditions, the user should set up the device in the coldest area of the room.

The device should not be exposed to direct sunlight or precipitation or installed near heat sources (radiators, wall heating systems, etc.).

The device should not be operated in the vicinity of devices emitting strong electromagnetic fields, e.g.: X-ray, CT scanners, MRI machines, etc.



#### **WARNING**

- After the device is delivered, check its technical condition and equipment according to the instructions for use; notify the seller of any damage within 24 hours.
- At the place of use, level the device and if the product has castors, lock the brakes.
- Keep the device in good working condition.
- It is recommended that products to be stored in low-temperature devices be pre-frozen.
- Do not overload the device, i.e. ensure that the loading is in accordance with the technical data and observe the permissible load on the shelves.
- Load the interior of the storage device after it has been previously frozen.
- Position the stored products in such a way as to allow air circulation through the evaporator and inside the device.
- **Never cover or obstruct the device's vents;**
- **Never use mechanical equipment and other means to accelerate thawing.**
- **Tampering, altering or damaging the refrigerant circuit is strictly prohibited**
- **It is prohibited to use electrical equipment inside the refrigeration compartment, except for those for which the manufacturer allows it.**
- Use water and dishwashing detergent and a soft cloth or sponge to wash the device's interior; always disconnect the device from the mains beforehand.
- Vacuum the front surface of the condenser every two months, and do this more often if the area is dustier.
- Open the door for the shortest possible time.
- Use only the equipment and accessories supplied with the refrigeration device,
- When arranging the cabinets in a row, keep a minimum distance of 10 cm between them. Failure to maintain this spacing will result in dew forming in the space between the cabinets.



#### WARNING

If the cabinets are arranged in a row, their bodies should be connected by an equipotential bonding cable. This operation may only be carried out by an authorised person.

If damaged, disconnect the device from the mains and have it repaired.

The manufacturer recommends that people using the device be trained in the operation of the device, as well as have training in basic health and safety.



#### WARNING

Connect the device to the mains with a functioning system protecting against electric shock.

### 3.2 Safety instructions for using the device.



#### WARNING

It is strictly prohibited to:

- connect the device to the mains without making sure that the electric shock protection is working properly;



#### CAUTION

- cover or obstruct the vents of the device,
- tilt the device at an angle greater than 45°, however, if it is necessary, wait for approximately 1h before starting the device (otherwise you risk damaging the compressor),
- position the devices close to heat sources,
- position the devices in the vicinity of electromagnetic field emitters

Qualified personnel, service technicians or an employee of BOLARUS S.A. should carry out annual technical safety checks on the device for a fee.

Each service intervention should be recorded in the service log for the device.



**Clean the condenser and air filter at least once every 2 weeks. (See section 12.2) For rooms with a higher presence of dust, it should be repeated more often. This is the responsibility of the user. When cleaning the condenser, wearing of protective gloves is recommended – risk of injury.**

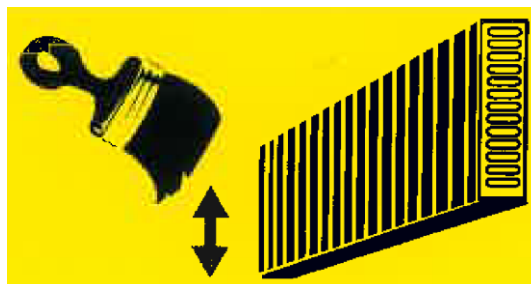

Symbol indicating the need for regular cleaning of the condenser –

It is recommended to brush with a soft brush in up and down strokes and then vacuum thoroughly. For heavier dirt, use compressed air, avoiding possible damage to the condenser fins.

The device's nameplate is located at the top of the left side. It specifies the electrical supply requirements and the serial number of the device.

### 3.3. Safety instructions regarding the impact of the environment



#### WARNING

- If the device is exposed to strong magnetic fields (e.g. radiotherapy and surgical devices), malfunctions may occur. In this case, increase the separation between the device and the interfering device or avoid using both devices simultaneously.
- The device can be affected by portable and personal devices such as, for example, cell phones
- Before moving the device, disconnect it from the power source by pulling the plug from the socket
- Place the device on a flat horizontal surface. Once set, lock the front castors.
- The device must not be used in the vicinity of:
  - ✓ flammable materials (e.g. gases, liquids),
  - ✓ flammable mixtures of anesthetics with air,
- The device must not be used in close proximity to equipment that generates heat.
- The device must not be placed directly next to or stacked with other devices. If it is necessary to use the device near other equipment, check that operation is running smoothly.
- Arrange the products so that they do not interfere with the air circulation inside the device.

### 4. Symbols used



**Disconnect the device from the power source before opening the housing. Danger to life and limb may occur. Only qualified professionals with electronic or other related training are authorized to open the housing.**



Follow these Instructions for Use at all times! Failure to do so may result in danger to life and limb and risk of equipment damage.



Grounding designation.  
Used only on the device's interior.



This symbol indicates that the product must not be disposed of with household waste. For disposal, the device must be taken to a specialised collection point or sent back to the manufacturer.



### 5. Start-up

**Before the first start-up of the product, disinfect the device with generally used disinfectants according to the notes in section 7.1.**

### **5.1. Setting up the device**

- The low-temperature device should be placed in an area that does not experience significant temperature fluctuations or drafts and is not exposed to sunlight. Any of these factors can adversely affect temperature regulation.
- The low-temperature device should not be installed on the production floor near pressure welding machines, welders, etc. which emit strong electromagnetic fields.
- The device can only be set up on flat, horizontal surfaces.
- After setting up any devices equipped with castors, the front castors must be locked. This prevents unintentional movement of the device, e.g. when opening doors.
- The device must be placed in a spot that allows the door to open fully. Please consider the ambient conditions listed in the technical data when setting up the device. In addition, there should be a good supply and discharge of air to and from the condenser.

**Users must follow the recommendations below:**

- **the room must have adequate ventilation,**
  - **the room must be at least 50 cm higher than the tallest element of the device body,**
  - **the low-temperature device must be positioned at least 15 cm away from the wall of the room,**
  - **a minimum of 15 cm of free space must be maintained between the sides of the device.**
- The device generates heat while active. Free air circulation and ventilation must be provided to allow the heat to vent.

**Installing the device in a room that does not meet the above requirements will void the warranty.**

### **5.2. Connection to the power grid**

**The low-temperature device is designed to be connected to a power grid with a protective earthing conductor (TN-S system).**

For power grids using a different earthing method, please consult with BOLARUS S.A. on how to connect your device.

The power grid (plug socket with a protective contact) must comply with the technical data on the device's nameplate and the applicable regulations for electrical systems.

The low-temperature device is powered from the mains via a power cord. Connect the plug of the power cord to a grounded plug socket.

### **5.3. Switching the low-temperature device on and off.**

To start the device, follow these steps:

- Plug the power cord into a socket
- Switch the ON/OFF button, B6A installation switch is located on the right side



- Wait about 30 sec, until the controller starts up
- Set / check the temperature setpoint
- Start the device using the touch panel
- Press ON (the controller will ask for a password, password: 1111)
- After entering the password, wait 4 sec. and select START from the menu.
- The system will start.

To turn off the device, follow these steps:

- Turn off the device using the touch panel
- Press OFF (the controller will ask for a password, password: 1111)
- After entering the password, wait 4 sec. and select STOP from the menu.
- Switch the side switch to the OFF position and switch the B6A installation switch
- Unplug the power cord from the socket.

## 6. HMI TOUCH 7 controller user manual:

Low-temperature devices are equipped with electronic controllers to ensure optimal use of their capabilities. Manufacturer programs these controllers based on in-depth studies and customer feedback. Nonetheless, the controller may need to be reprogrammed to match the customer's needs, e.g. where the room is too humid or the turnover of stored products is very high. This must be agreed upon with the manufacturer before purchasing the device. There are two groups of controller settings:

- available to the user,
- available to service technicians (these parameters can only be changed with the manufacturer's approval).

The operation of the device is fully automated. The manufacturer pre-sets the parameters of the electronic thermostat to ensure that the user can adjust the interior temperature range (making it user-adjustable). The method of setting the desired temperature is described in the appendix to these Instructions for Use, based on the temperature controller used. Any change in the system parameters available to service technicians can be made only with the manufacturer's approval.

### 6.1. Controller specifications

The controller in low-temperature cabinets is mounted on the door at a height that allows ergonomic operation and good visibility of the displayed parameters. The HMI TOUCH 7 panel is used in low-temperature devices. A large easy-to-read screen and simple menu make the device easy to use.

The control panel features:

- 7 inch display (193 x 125 x 16 mm)
- Touch panel
- Temperature control in 0.1°C increments
- Temperature graph view
- Compartment temperature sensor
- Compressor temperature sensor
- Evaporator temperature sensor
- Ambient temperature sensor
- Reminder to clean the condenser periodically
- RS 485 wired interface

- Battery backup for temperature recording and display
- USB connector
- RJ
- High/low temperature alarm
- Door open alarm
- Dirty condenser alarm
- Sensor failure alarm
- Compressor failure alarm
- Power failure alarm

The home screen menu displays:

- Current date and time
- Device status information: OPERATING / STOP
- Operation switch
- Information about the current temperature in the compartment
- Ambient temperature information
- Maximum and minimum temperature indicator
- Compressor operation information
- Graph view
- Alarm view

## 6.2. HMI control panel operation

The HMI supports graphical displays, SLIDEBAR menu, and TEXT menu. The first screen shows the main tabs of the HMI - this is a graphic menu. Move between graphical displays by swiping on the screen to left or right.

The SLIDEBAR submenu can be accessed by swiping on the screen from top to bottom (while in the graphic menu).



From the SLIDEBAR menu, submenus can be accessed: MAIN MENU, HMI MENU, ALARMS, GRAPH.

The submenu can be accessed by pressing the icon with the right description.





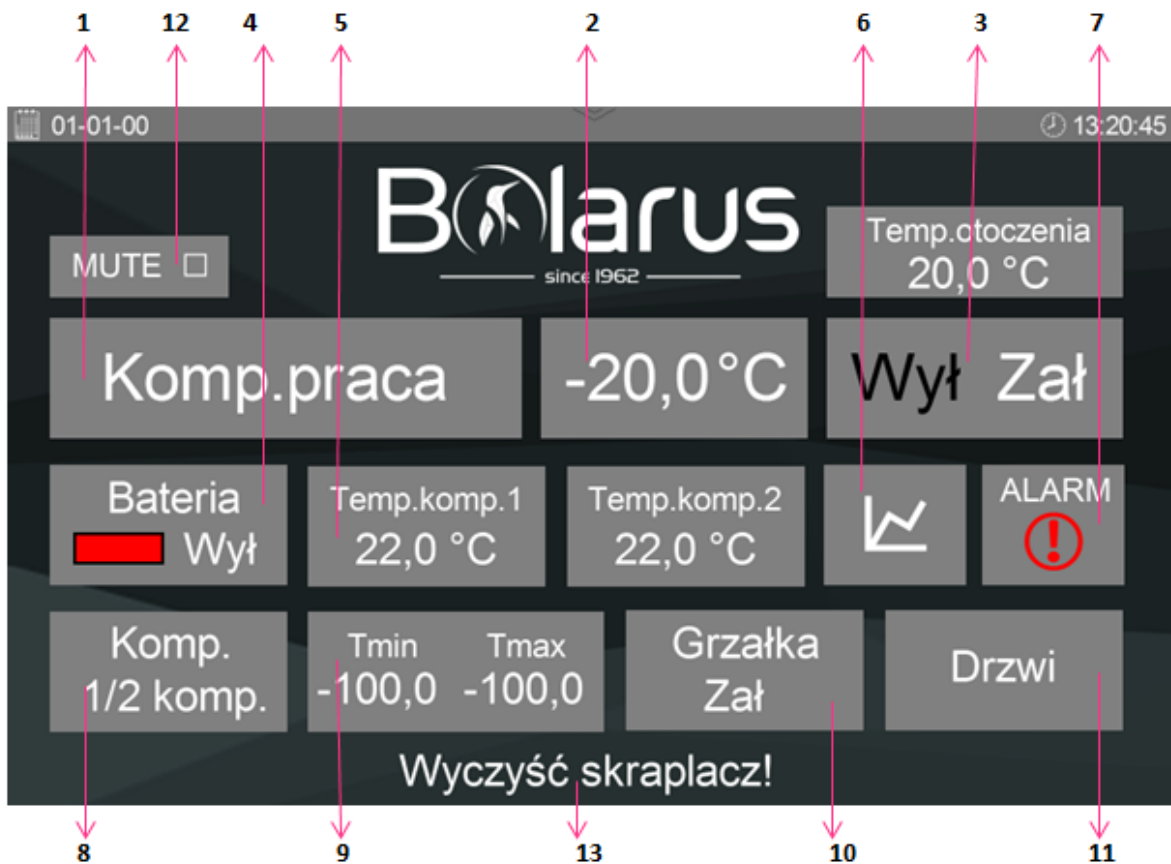



Exit the submenu by swiping on the screen from left to right.

### 6.3. Description of the home screen

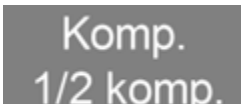
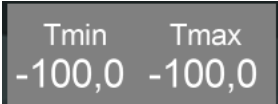

#### Functions of individual buttons/fields:

| Graphic view | Description  |
|--------------|--|
|              | A box indicating the current operating status of the device.<br>Possible status:<br><b>Stop</b> - device is not operating<br><b>Comp.Operation</b> - proper operation of the device<br><b>Comp.Stop</b> - device stopped due to minimum compressor downtime<br><b>Stop-failure</b> - device stopped due to failure |
|              | A box indicating the current temperature of the device. When pressed, it allows changing the temperature setpoint. See point 3   |
|              | Box for switching the system on/off.   |

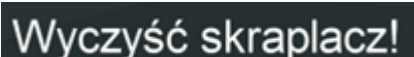
|   |   |
|---|---|
|    | <p>The box shows whether the device is operating on battery power (ON) or direct power (OFF). When operating on battery power, the battery icon symbolises the battery state of charge (green - OK, red - low charge)</p>   |
|    | <p>Box showing the current temperature of the compressor 1/2</p>  |
|    | <p>Icon for accessing the graphs menu</p>   |
|    | <p>Icon indicating all alarms. When pressed, allows access to the alarm menu</p>  |
|    | <p>A box showing the current status of the compressors. Possible status:<br/> <b>Stop</b> - compressor is not operating<br/> <b>1 comp.</b> - the first compressor is operating<br/> <b>2 comp.</b> - the second compressor is operating<br/> <b>1/2 comp.</b> - both compressors are operating</p> |
|  | <p>Minimum and maximum compartment temperature measured over a 24-hour period</p>   |
|  | <p>A box indicating the operation of the frame heater.</p>  |
|  | <p>A box for accessing the statistics on the opening of the door.</p>   |
|  | <p>Box for turning off the alarm</p>  |
|  | <p>Information displayed when the condenser needs to be cleaned</p>   |

#### 6.4. Setting the desired temperature

To change / set the desired temperature:

1. Click on the temperature icon - button 2
2. Note: the controller is protected by the default password 1111 - you will be asked to enter the password. It is recommended to change the password after the first startup
3. If the correct password has been entered, confirm it with the OK button
4. The temperature setpoint can be changed using the arrows. Alternatively, clicking on the temperature value will open the keyboard (Fig. 2.) that allows entering the desired value.

5. Accept the setting by pressing the OK button

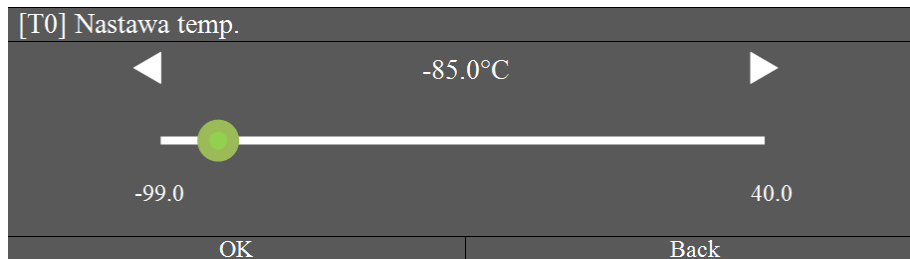

| [T0] Nastawa temp. |   |   |   |      |
|--------------------|---|---|---|------|
|                    |   |   |   | -85  |
| -                  | 7 | 8 | 9 | <<   |
| .                  | 4 | 5 | 6 | Back |
| 0                  | 1 | 2 | 3 | OK   |

Fig. 2

Nastawa temp.

Temperature setpoint

## 6.5. Temperature graph generation

To generate a temperature graph:

1. Press the graph icon - button 6



2. The message "add trend logs" will appear.

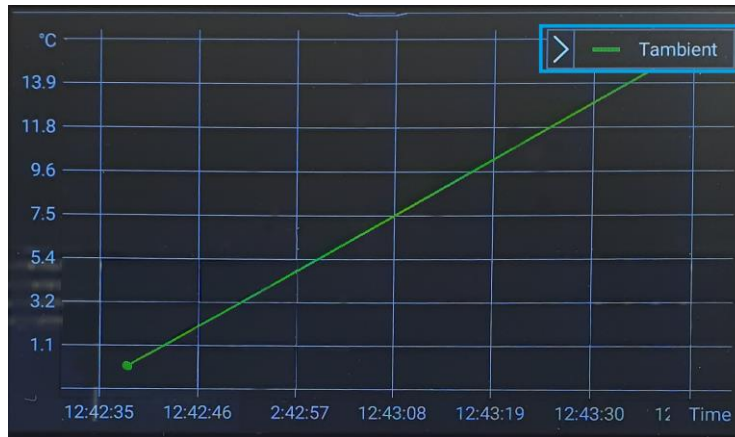

3. Select 1 or more graphs that can be displayed on the screen
4. Confirm the list of graphs by clicking OK
5. To scale the graph, press the upper left button. You can scale it in the time axis and in the temperature axis. If you click on and hold the temperature axis, the graph will show the temperature progression over time from highest to lowest.
6. To exit the "Graphs" menu, pull down the toolbar.



## 6.6. Setting the date and time

1. Click on the HMI MENU icon

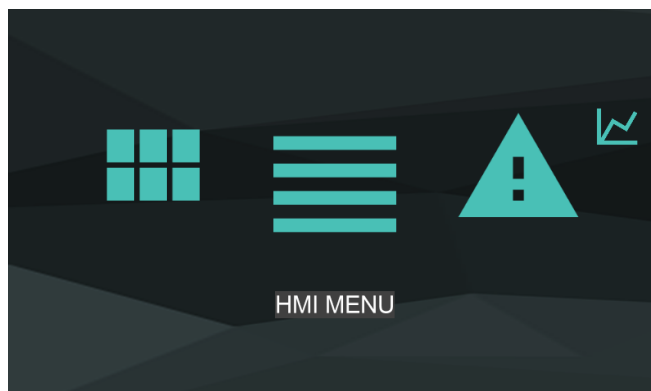

2. Click on the User Menu icon

|                  |          |
|------------------|----------|
| Freezer>         |          |
| Data             | 18-02-21 |
| Godzina          | 11:12:25 |
| Stan układu      | Stop     |
| Menu użytkownika |          |
| Menu serwisowe   |          |
| v.8.1 09-04-21   | Freezer  |
| Bolarus          |          |

|                  |               |
|------------------|---------------|
| Data             | Date          |
| Godzina          | Time          |
| Stan układu      | System status |
| Menu użytkownika | User's menu   |
| Menu serwisowe   | Service menu  |

3. Enter the password (standard 1111) and confirm with "ok"

|       |   |   |   |      |
|-------|---|---|---|------|
| Hasło |   |   |   |      |
|       |   |   |   | 0    |
| -     | 7 | 8 | 9 | <<   |
| .     | 4 | 5 | 6 | Back |
| 0     | 1 | 2 | 3 | OK   |

|       |          |
|-------|----------|
| Hasło | Password |
|-------|----------|

4. Click on the Date and Time icon

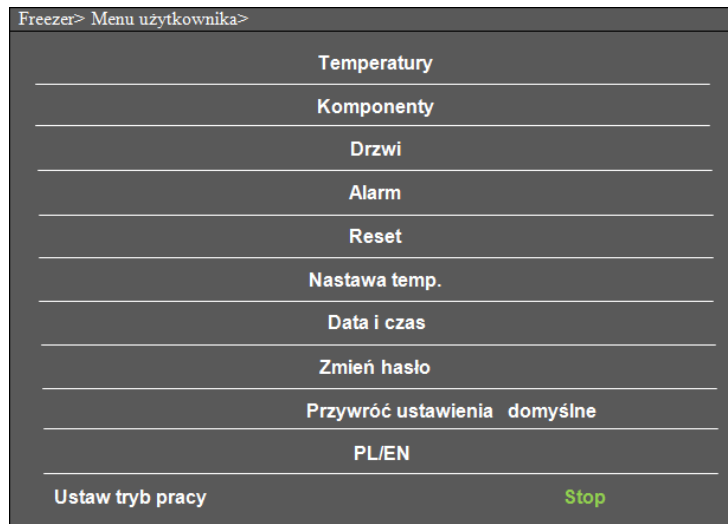

|                             |                          |
|-----------------------------|--------------------------|
| Menu użytkownika            | User's menu              |
| Komponenty                  | Components               |
| Drzwi                       | Door                     |
| Alarm                       | Alarm                    |
| Reset                       | Reset                    |
| Nastawa temp.               | Temperature setpoint     |
| Data i czas                 | Date and time            |
| Zmień hasło                 | Change password          |
| Przwróć ustawienia domyślne | Restore default settings |
| Ustaw tryb pracy            | Set operation mode       |

5. Set the date/time with the slider

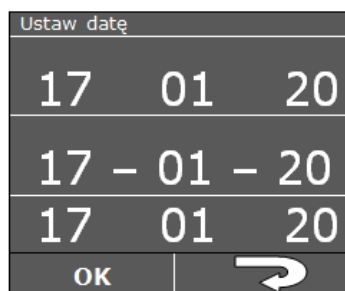

Ustaw datę                      Set the date

6. Confirm the change with the OK button
7. To leave the Menu, pull down the toolbar

### 6.7. Resetting the "Clean condenser" notification

The device reminds the user to clean the condenser periodically. The message should be manually reset after the condenser condition check. To reset the message, follow these steps:

1. Click on the "Clean condenser" message



2. Enter the password (standard 1111)
3. Confirm that the condenser has been cleaned by changing the value to "yes"

|   |          |
|---|----------|
| Freezer> Menu użytkownika> Reset> Czyszczenie skraplacza> |          |
| Czyszczenie skraplacza                                    | Nie      |
| Czyszcz.data  | 14-00-00 |
| Reset   | Nie      |

|                        |                        |
|------------------------|------------------------|
| Menu użytkownika       | User's menu            |
| Czyszczenie skraplacza | Cleaning the condenser |
| Czyszcz.data           | Clean.date             |
| Nie                    | No                     |

The message will be displayed again after the programmed (Clean.date) interval has elapsed.

### 6.8. List of Alarms

The alarm icon may be inactive or highlighted in red.

The red exclamation mark indicates the alarm status of the device. In addition, a sound signal may be activated.

**Note:** the controller can be equipped with a MUTE button. Pressing it turns off the sound signal for a certain period of time. The MUTE button does not clear the alarm.

|                               |                |
|-------------------------------|----------------|
| Active Alarms  Alarms History |                |
| 01-09 13:27:28                | A_PowerFailure |
| 01-09 12:27:28                | A_Door1        |
| 30-08 12:27:28                | A_Thigh        |

1. Click on the alarm icon - button 7 - to access the alarm menu



2. You can analyse the following alarms:
  - a) Current (Active Alarms)
  - b) Historical (Alarms History)
3. It is not possible for the user to clear a fading alarm - clearing occurs automatically when the cause disappears.

| ALARMS               | Alarm type | System response, handling   |
|----------------------|------------|---|
| Digital inputs       |            |   |
| A_Door1              | Fading     | Works together with the door limit switch<br>Normal status - door open, 24V signal at digital input<br>Alarm status - door closed, no 24V signal at digital input<br><br>Possible change from NO to NC<br>Response to alarm status: informational alarm, after the alarm stops, the system automatically returns to the operating state from before the alarm<br><b>Din1 digital input</b>  |
| A_Door1              | Fading     | Works together with the door limit switch 2<br>Normal status - door open, 24V signal at digital input<br>Alarm status - door closed, no 24V signal at digital input<br><br>Possible change from NO to NC<br>Response to alarm status: informational alarm, after the alarm stops, the system automatically returns to the operating state from before the alarm<br><b>Din2 digital input</b>  |
| A_PowerFail          | Blocking   | Check of the system's power source:<br>Normal status - constant power supply, 24V signal at digital input<br>Alarm status - battery backup, no 24V signal at digital input<br><br>Possible change from NO to NC<br>Response to alarm status: When the A_PowerFail alarm is activated, the system operation is stopped, the backlight is reduced and the "backlight reduced" alarm is displayed requiring confirmation.<br><b>Din3 digital input</b> |
| A_LowBatter          | Fading     | Check of the battery voltage status:<br>Normal status - 24VAC signal at digital input<br>Alarm status - no 24VAC signal at digital input<br><br>Response to alarm status: informational alarm, after the alarm stops, the system automatically returns to the operating state from before the alarm<br>Possible change from NO to NC<br><b>Din4 digital input</b>   |
| PT1000 sensor inputs |            |   |
| A_Tambient           | Fading     | Check of the proper operation of the ambient temperature sensor:<br>Normal status - no alarm, sensor connected<br>Alarm status - alarm activated, sensor disconnected or damaged<br>Response to alarm status: informational alarm, check the sensor and how it is connected to the controller, determine the cause of the error. After removing the cause, confirm the alarm and start the system<br><b>PT1 sensor input</b>                        |
| A_Tchamber           | Fading     | Check of the correct operation of the chamber temperature sensor:<br>Normal status - no alarm, sensor connected   |

|                       |          |   |
|-----------------------|----------|---|
|                       |          | Alarm status - alarm activated, sensor disconnected or damaged<br>Response to alarm status: informational alarm, check the sensor and how it is connected to the controller, determine the cause of the error. After removing the cause, confirm the alarm and start the system<br><b>PT2 sensor input</b>  |
| <b>A_TcompCooling</b> | Fading   | Check of the correct operation of the compressor subcooling temperature sensor:<br>Normal status - no alarm, sensor connected<br>Alarm status - alarm activated, sensor disconnected or damaged<br>Response to alarm status: informational alarm, check the sensor and how it is connected to the controller, determine the cause of the error. After removing the cause, confirm the alarm and start the system<br><b>PT3 sensor input</b> |
| <b>A_Tcomp1</b>       | Fading   | Check of the correct operation of the compressor temperature sensor 1<br>Normal status - no alarm, sensor connected<br>Alarm status - alarm activated, sensor disconnected or damaged<br>Response to alarm status: informational alarm, check the sensor and how it is connected to the controller, determine the cause of the error. After removing the cause, confirm the alarm and start the system<br><b>PT4 sensor input</b>           |
| <b>A_Tcomp2</b>       | Fading   | Check of the correct operation of the compressor temperature sensor 2<br>Normal status - no alarm, sensor connected<br>Alarm status - alarm activated, sensor disconnected or damaged<br>Response to alarm status: informational alarm, check the sensor and how it is connected to the controller, determine the cause of the error. After removing the cause, confirm the alarm and start the system<br><b>PT5 sensor input</b>           |
| Other alarms          |          |   |
| <b>A_Thigh</b>        | Fading   | Check of the correct temperature in the chamber:<br>Normal status - temperature ok<br>Alarm status - temperature too high<br>Response to alarm status: informational alarm, check the cause of high temperature, determine the cause of the error. When the alarm stops, the system will automatically return to the operating state from before the alarm  |
| <b>A_Tlow</b>         | Fading   | Check of the correct temperature in the chamber:<br>Normal status - temperature ok<br>Alarm status - temperature too low<br>Response to alarm status: informational alarm, check the cause of low temperature, determine the cause of the error. When the alarm stops, the system will automatically return to the operating state from before the alarm  |
| <b>A_Comp1/2Start</b> | Blocking | When the compressor is turned on, the compressor discharge temperature is measured. If the temperature does not rise by at least T18 after this time, a compressor alarm will be reported.<br>Normal status - no alarm  |

|                      |          |   |
|----------------------|----------|---|
|                      |          | <p>Alarm status - alarm activated</p> <p>Alarm status response:</p> <ul style="list-style-type: none"> <li>- STOP system (system with one compressor)</li> <li>- STOP compressor failure (system with two compressors)</li> <li>- switching one compressor to the other (system with rotation)</li> <li>- check the compressor and determine the cause of the error. After removing the cause, confirm the alarm and start the system</li> </ul>  |
| <b>A_Comp1/2Work</b> | Blocking | <p>When the compressor is operating, the compressor discharge temperature must not drop by more than the T19 setpoint.</p> <p>Normal status - no alarm</p> <p>Alarm status - alarm activated</p> <p>Alarm status response:</p> <ul style="list-style-type: none"> <li>- STOP system (system with one compressor)</li> <li>- STOP compressor failure (system with two compressors)</li> <li>- switching one compressor to the other (system with rotation)</li> <li>- check the compressor and determine the cause of the error. After removing the cause, confirm the alarm and start the system</li> </ul> |
| <b>A_In_Emul</b>     | Fading   | <p>Emulation of inputs:</p> <p>Normal status - no alarm, no inputs are in emulation mode</p> <p>Alarm status - at least one of the digital, analog, PT1000 inputs is in emulation mode</p> <p>Response to alarm status: the controller does not respond to physical changes in the emulated input, the system works with the value from the emulator in the service menu</p>  |
| <b>A_OutForce</b>    | Fading   | <p>Forcing outputs:</p> <p>Normal status - no alarm, no outputs are in forcing mode</p> <p>Alarm status - at least one of the digital, analog outputs is in forcing mode</p> <p>Response to alarm status: the system works but the output in forcing mode does not respond to the control algorithm; it is set using the "output forcing" menu in the service menu</p>  |

## 6.9. Alarm clearing

In the event of a lockout alarm, it is necessary to clear the alarm to resume operation of the automatic system. To clear an alarm, go to the "Alarm Menu" and click on and hold the line describing the active alarm. If the cause of the alarm is still present then the alarm will continue and the symbol "\*" will appear next to the description of the alarm. In this case, contact the service centre. If the cause of the alarm has ceased or will cease after confirmation, the alarm will be cleared.



A detailed description can be found in the controller manual enclosed with the device.

## 6.10. Language setting

1. Click on the HMI MENU icon

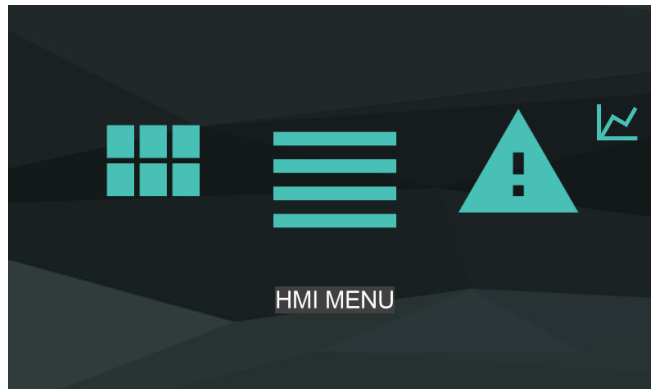

2. Click on the User Menu icon
3. Enter the password (standard 1111) and confirm with "ok"
4. Click on the PL/EN icon

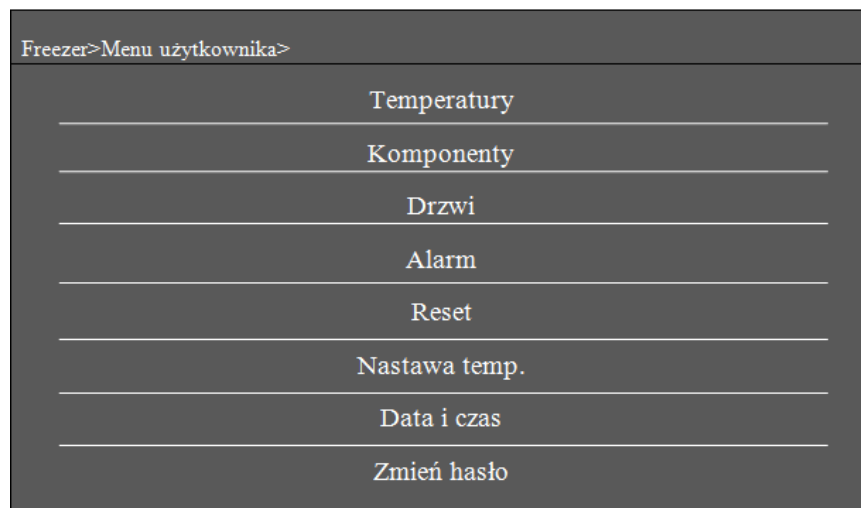

|                             |                          |
|-----------------------------|--------------------------|
| Menu użytkownika            | User's menu              |
| Komponenty                  | Components               |
| Drzwi                       | Door                     |
| Alarm                       | Alarm                    |
| Reset                       | Reset                    |
| Nastawa temp.               | Temperature setpoint     |
| Data i czas                 | Date and time            |
| Zmień hasło                 | Change password          |
| Przwróć ustawienia domyślne | Restore default settings |
| Ustaw tryb pracy            | Set operation mode       |

5. Set the software language

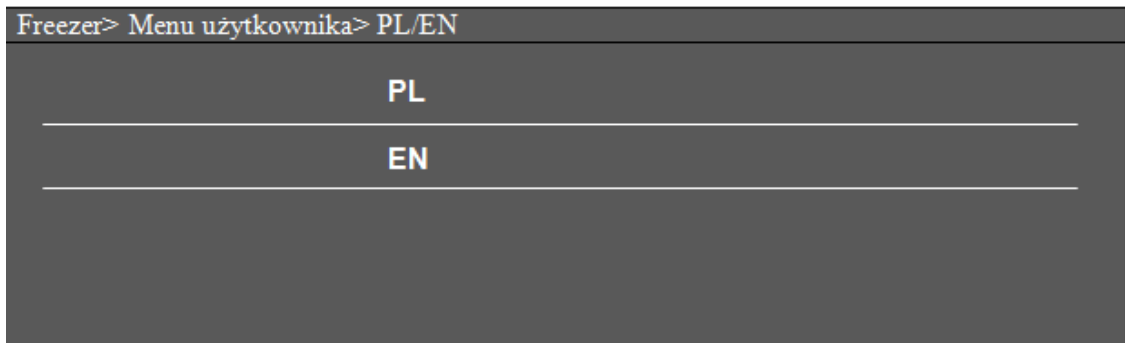

Menu użytkownika

User's menu

6. To leave the Menu, pull down the toolbar

## 7. **Assembly and maximum load of shelves**

Low-temperature cabinets are equipped with one fixed shelf and two shelves whose position can be set (ULTU400 and ULTU600). The ULTU100 cabinet, on the other hand, is equipped with one movable shelf. The spacing between shelf levels is 12.3 mm.

It is recommended that the shelf be positioned so that it is at the height of the lower edge of the inner door.

### 7.1. **Shelf assembly**

To change the position of the shelf:

- a) Disconnect the device from the mains
- b) Remove the shelf
- c) Remove the fasteners from their original position
- d) Place the fasteners on the shelf supports
- e) Fix the shelf and check its stability

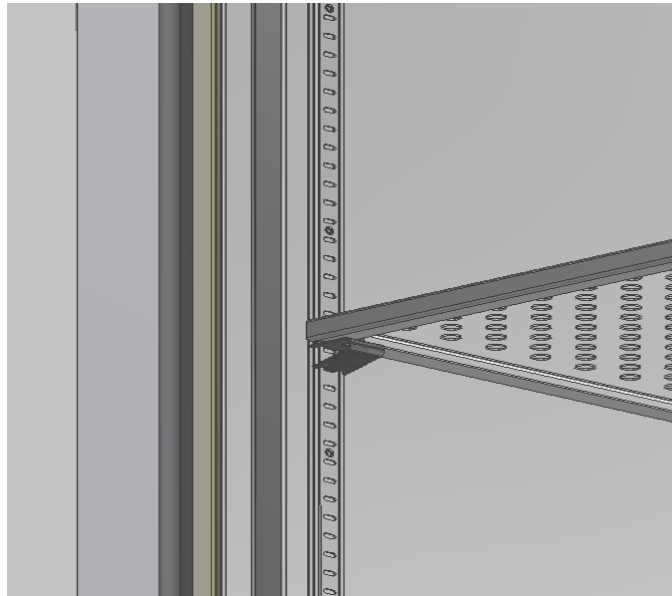

Carry out the above steps with protective gloves on and extreme caution - possibility of frostbite and/or cuts.

#### **7.2 . Maximum standard shelf load**

The maximum standard shelf load in ULTU400 and ULTU 600 cabinets is 40 kg.

The maximum standard shelf load in the ULTU100 cabinet is 25 kg.

#### **8. Cabinet door handle**

- ULTU type cabinet is equipped with a handle that can be locked with a key. During operation, pay attention to the operation of this mechanism and closing of the door correctly
-  Avoid slamming the door - risk of damaging the handle and the lock.

#### **9. Exporting data**

Electronic controller TOUCH 7 has the function of reading data stored inside the memory of the recorder. To carry out this operation, a computer equipped with a USB port and the TrendLogReader application is required. ULTU low-temperature cabinet must be connected to the power supply, controller status unrestricted.

1. Save the folder containing the TrendLogReader application on the desktop.
2. Connect the USB cable to the computer. The socket or cable is located on the right side of the device, inside a slot.



3. Open the TrendLogReader application.

| Nazwa                 | Data modyfikacji | Typ                   | Rozmiar |
|-----------------------|------------------|-----------------------|---------|
| BACnet.dll            | 10.11.2020 15:36 | Rozszerzenie aplik... | 308 KB  |
| Communication.cnf     | 25.01.2021 08:32 | Plik CNF              | 1 KB    |
| Communication.dll     | 10.11.2020 15:36 | Rozszerzenie aplik... | 19 KB   |
| CommunicationSettings | 17.10.2016 10:33 | Aplikacja             | 57 KB   |
| komora.csv            | 25.01.2021 08:33 | Plik CSV              | 891 KB  |
| TrendLogReader        | 09.01.2021 19:39 | Aplikacja             | 22 KB   |

4. Press the Read Trend Logs box.

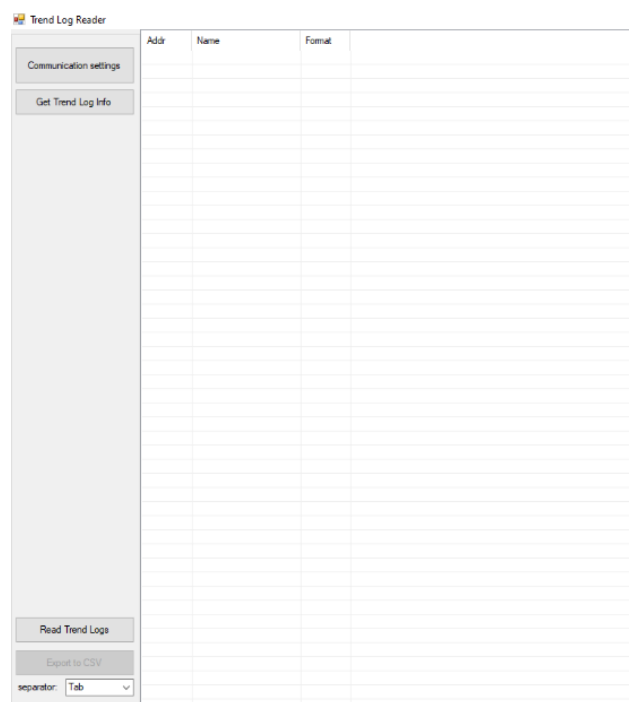

5. The application will connect to the controller and read the list of available trends.



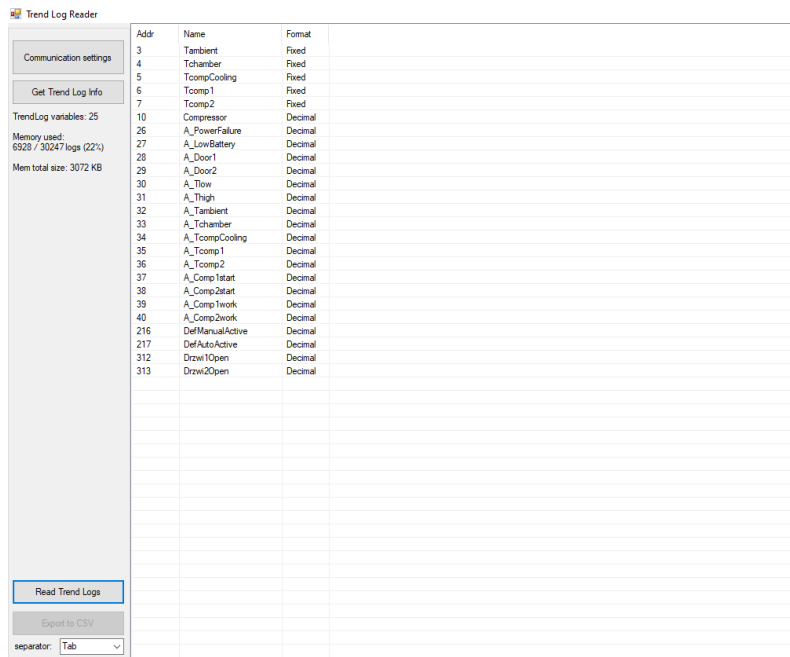

6. Wait until the application downloads data from the controller's memory (green slider).
7. Press the box named Tchamber, the row will be highlighted.
8. Press the Export to CSV box
9. Determine the location of the data file

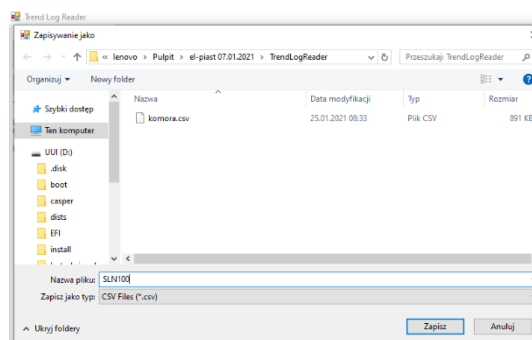

10. The application saved the data correctly

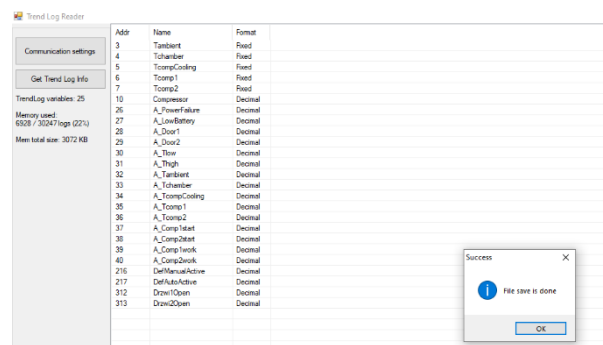

11. Open the saved file using notepad

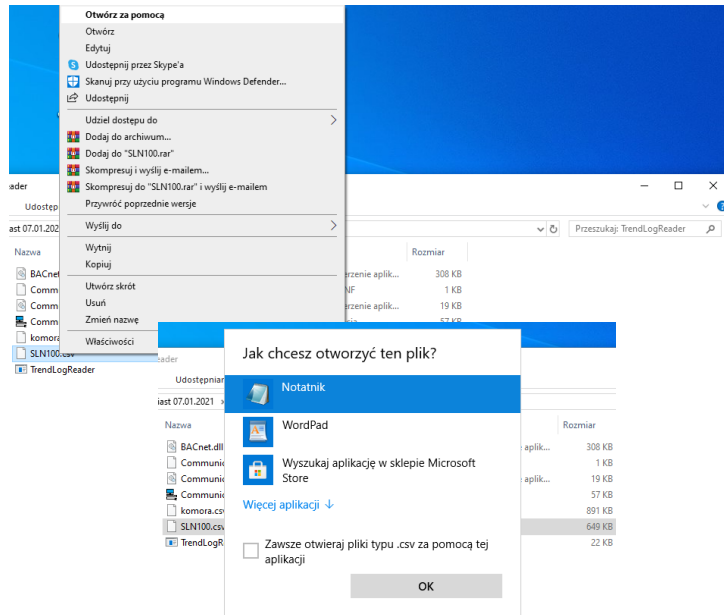

12. Example view of stored data

| date                | Tambient | Tchamber | TcompCooling | Tcomp1 | Tcomp2 | Compressor | A_PowerFailure | A_LowBattery | A_Door1 | A_Door2 | A_Tlow | A_... |
|---------------------|----------|----------|--------------|--------|--------|------------|----------------|--------------|---------|---------|--------|-------|
| 20.01.2021 14:45:16 | 0        | 0        | 0            | 0      | 0      | 0          | 0              | 0            | 0       | 0       | 0      | 0     |
| 20.01.2021 14:46:18 | 19,602   | 19,477   | 19,602       | 18,891 | 18,918 | 0          | 0              | 0            | 0       | 0       | 0      | 0     |
| 20.01.2021 14:47:18 | 19,574   | 19,496   | 19,613       | 18,973 | 18,988 | 0          | 0              | 0            | 0       | 0       | 0      | 0     |
| 20.01.2021 14:48:20 | 19,559   | 19,496   | 19,555       | 19,039 | 19,008 | 0          | 0              | 0            | 0       | 0       | 0      | 0     |
| 20.01.2021 14:49:20 | 19,582   | 19,527   | 19,465       | 19,059 | 18,996 | 0          | 0              | 0            | 0       | 0       | 0      | 0     |
| 20.01.2021 14:50:16 | 19,566   | 19,508   | 19,445       | 19,07  | 18,988 | 0          | 0              | 0            | 0       | 0       | 0      | 0     |
| 20.01.2021 14:50:22 | 19,559   | 19,508   | 19,434       | 19,07  | 18,977 | 0          | 0              | 0            | 0       | 0       | 0      | 0     |
| 20.01.2021 14:51:22 | 19,559   | 19,516   | 19,355       | 19,07  | 18,938 | 0          | 0              | 0            | 0       | 0       | 0      | 0     |
| 20.01.2021 14:52:24 | 19,527   | 19,527   | 19,355       | 19,059 | 18,918 | 0          | 0              | 0            | 0       | 0       | 0      | 0     |
| 20.01.2021 14:53:24 | 19,559   | 19,555   | 19,484       | 19,117 | 18,977 | 0          | 0              | 0            | 0       | 0       | 0      | 0     |
| 20.01.2021 14:54:26 | 19,559   | 19,578   | 19,602       | 19,164 | 19,047 | 0          | 0              | 0            | 0       | 0       | 0      | 0     |
| 20.01.2021 14:55:16 | 19,527   | 19,547   | 19,504       | 19,164 | 19,047 | 0          | 0              | 0            | 0       | 0       | 0      | 0     |
| 20.01.2021 14:55:26 | 19,547   | 19,547   | 19,496       | 19,164 | 19,047 | 0          | 0              | 0            | 0       | 0       | 0      | 0     |
| 20.01.2021 14:56:28 | 19,559   | 19,547   | 19,445       | 19,184 | 19,047 | 0          | 0              | 0            | 0       | 0       | 0      | 0     |
| 20.01.2021 14:57:28 | 19,539   | 19,547   | 19,387       | 19,176 | 19,027 | 0          | 0              | 0            | 0       | 0       | 0      | 0     |
| 20.01.2021 14:58:30 | 19,883   | 19,938   | 22,063       | 27,355 | 19,949 | 1          | 0              | 0            | 0       | 0       | 0      | 0     |
| 20.01.2021 14:59:30 | 19,809   | 19,742   | 22,004       | 31,094 | 19,957 | 1          | 0              | 0            | 0       | 0       | 0      | 0     |
| 20.01.2021 15:00:16 | 19,848   | 19,707   | 22,023       | 33,809 | 20,137 | 3          | 0              | 0            | 0       | 0       | 0      | 0     |
| 20.01.2021 15:00:18 | 19,848   | 19,707   | 22,023       | 33,809 | 20,137 | 3          | 0              | 0            | 0       | 0       | 0      | 0     |
| 20.01.2021 15:00:32 | 19,855   | 19,711   | 21,984       | 34,793 | 20,242 | 3          | 0              | 0            | 0       | 0       | 0      | 0     |
| 20.01.2021 15:00:52 | 19,895   | 19,707   | 22,043       | 35,668 | 20,332 | 3          | 0              | 0            | 0       | 0       | 0      | 0     |
| 20.01.2021 15:01:32 | 20,008   | 19,684   | 22,004       | 36,625 | 20,488 | 1          | 0              | 0            | 0       | 0       | 0      | 0     |
| 20.01.2021 15:02:34 | 20,492   | 19,695   | 21,73        | 35,906 | 20,898 | 1          | 0              | 0            | 0       | 0       | 0      | 0     |
| 20.01.2021 15:03:34 | 20,781   | 19,723   | 21,531       | 35,777 | 21,156 | 1          | 0              | 0            | 0       | 0       | 0      | 0     |
| 20.01.2021 15:04:36 | 19,711   | 19,859   | 22,203       | 38,859 | 25,191 | 3          | 0              | 0            | 0       | 0       | 0      | 0     |
| 20.01.2021 15:05:16 | 19,02    | 19,781   | 22,398       | 40,836 | 25,859 | 3          | 0              | 0            | 0       | 0       | 0      | 0     |
| 20.01.2021 15:05:36 | 18,898   | 19,75    | 22,277       | 41,211 | 25,613 | 3          | 0              | 0            | 0       | 0       | 0      | 0     |
| 20.01.2021 15:06:38 | 18,793   | 19,695   | 22,309       | 42,195 | 25,496 | 3          | 0              | 0            | 0       | 0       | 0      | 0     |

10.

**Decompression valves**

The device is equipped with an automatic and manual (optional) decompression valve.

**10.1 Automatic decompression valve**

ULTU-type devices are equipped with an automatic decompression valve. Ice may form in/around the valve causing blockage. In such a situation, when the door is opened and closed, a vacuum may build up inside the device, preventing it from opening again. In this case, it will be possible to reopen the device only after the pressure is equalised with the atmospheric pressure. This process can take approx. 20-30 minutes depending on the amount of iced formed around the valve. When periodically cleaning the device, take care to keep the decompression valve in good condition. The decompression valve must not be obstructed.

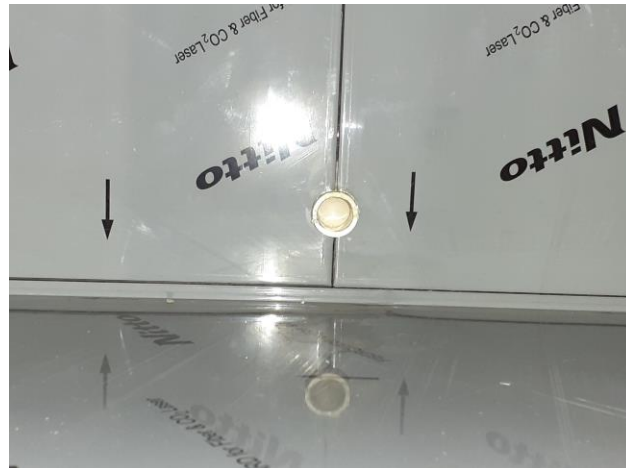

*Automatic decompression valve*

## **10.2. Manual decompression valve**

The device can be equipped with an additional manual decompression valve. It should be used if the device door has been sucked in. The valve is located on the right wall of the device directly above the communication port assembly. To use the additional valve, unscrew the plug of the decompression valve, then use a tool to unblock the hole (if there is too much ice), after which the pressure in the low-temperature compartment will equalise. This applies to ULTU 400 and ULTU 600 cabinets.



*Plug of the manual decompression valve*



**Carry out the above steps with protective gloves on and extreme caution - possibility of frostbite and/or cuts.**

**11. Access holes**

The device can have 9 access holes. All holes are pre-blinded by the manufacturer. For the installation of external temperature sensors, add a feedthrough in the designated place. Such an operation can only be performed by trained personnel. Making a hole in places other than those specified by the manufacturer may result in permanent damage to the body of the device.



**The above operation can only be performed by qualified personnel.**

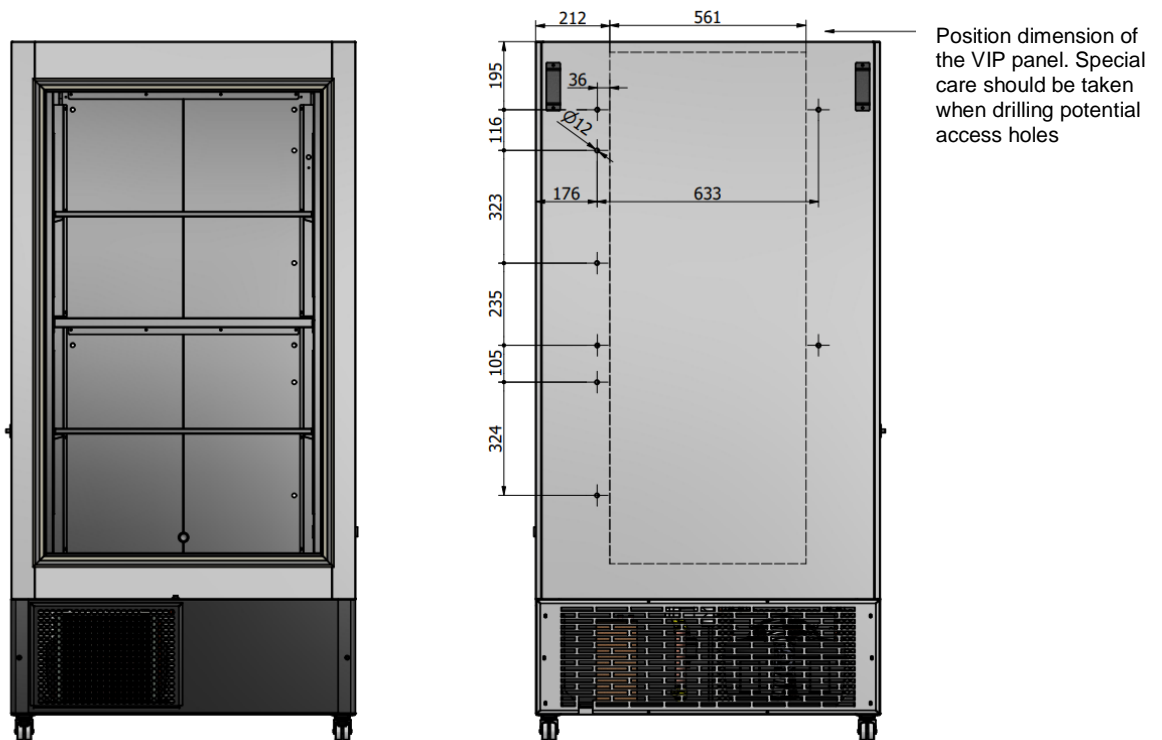

*Layout of access holes in the ULTU 400/600 cabinet*

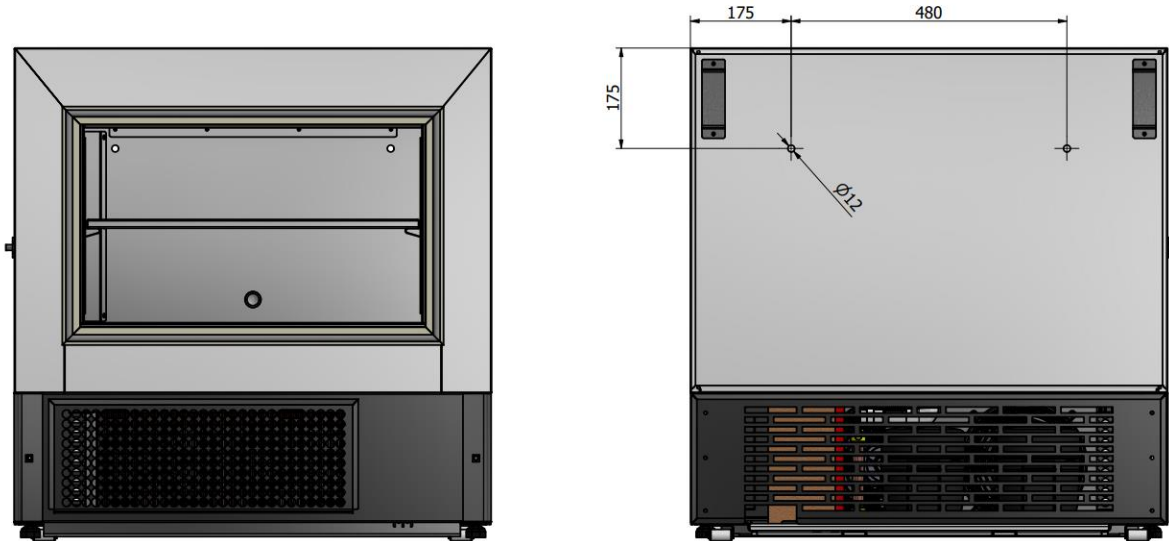

*Layout of access holes in the ULTU 100 cabinet*

## 12. Cleaning and maintenance

**Cleaning and periodic maintenance is the responsibility of the user. Before cleaning or carrying out a maintenance, the device must be unplugged by turning off the mains switch and removing the power cord plug from the socket.**

- Never soak or submerge the device in water,
- Never clean the device when it is unstable, i.e. the front castors must be locked,
- Do not use organic solvents (e.g. paint thinner, benzene, etc.),
- Never clean the device near a stream of running water.

### 12.1. Cleaning the device's interior and exterior

Low-temperature devices should be cleaned regularly.

**Before carrying out any maintenance or cleaning operations, turn off the device using the main switch and remove the plug from the power socket!**

**All repairs and maintenance work should be performed by trained personnel. Always ensure that no unaware person can turn on the device accidentally.**

For disinfection, use a slightly damp cloth and any surface cleaner.

Clean the device's interior, seals and profiles using a damp sponge soaked in warm water and/or neutral detergent and then wipe it with a soft cloth. Ethanol-based formulations can be used to remove oil or grease.

Never use preparations containing chlorine and its compounds, strong alkalis, acids, bleach or table salt (NaCl) to clean stainless steel surfaces.

Never use powders or other abrasive agents, silver cleaners, wire cleaners, cleaning wool, sharp cleaners or carbon steel brushes.

At set intervals, clean the device's condenser using a brush, vacuum cleaner or air compressor.

**NOTE!**



**Leave the door open if the device is out of operation. Wash and disinfect the device before using it again.**



**With regard to cleaning and disinfection of the device, please refer to the hygiene regulations applicable to the site where the device is operated.**

It is recommended that the mechanical lock and door hinges be lubricated regularly. Pay particular attention to the following during the periodic inspection:

- Operation of the mechanical door lock
- Door hinge operation
- Condition of door seals
- Internal door check
- Check and cleaning of the condenser

## 12.2. Maintenance and cleaning of the condenser

To clean the condenser:

- Disconnect the device from the power supply
- Remove the front cover and filter
- Clean the condenser

It is recommended to brush with a soft brush in up and down strokes and then vacuum thoroughly. For heavier dirt, use compressed air, avoiding possible damage to the condenser fins.



*Dirty condenser*

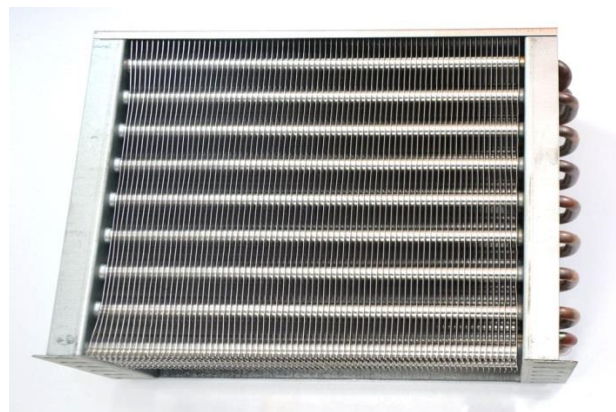

*Cleaned, vacuumed and washed condenser*



**WARNING**

**Before cleaning, the device must be disconnected from the power grid by pulling the plug from the socket. There is a risk of injury.**



**Clean the condenser and air inlets at least twice a month. For rooms with more dust, the cleaning should be repeated more often. This is the responsibility of the user.**

### 12.3. Defrosting

The device requires periodic defrosting. The specific nature of the operation of low-temperature cabinets does not allow the intervals of this operation to be strictly defined. Personnel are required to regularly check the level of icing of evaporators and seals. If excessive icing is observed, schedule periodic defrosting of the device.

The evaporators are located at the top of the cabinet and in the middle of its height. When opening doors 1 and 4, the elements are clearly visible.

During defrosting, control the amount of condensed water and regularly wipe the bottom of the device.

### 13. Practical advice

If the low-temperature device is not working properly, perform the following checks before calling a service technician:

#### **The device does not work.**

- Is the power cord plugged into a power socket?
- Is the socket live (with no blown fuses or residual protection tripped)?

The **temperature in the device has risen sharply** (signalled by an alarm on the display of the thermoregulator, logger).

- Has the device's door been opened frequently in recent times?
- Is the device overfilled with material or does the arrangement of the material impede the air circulation inside the device?
- Is the device's distance from the wall as stated in the Instructions for Use?
- Has the device's condenser been properly cleaned?
- Are the condenser and radiator fans running?

#### **the device works loudly**

- Is the device level?
- Does the material inside the device not vibrate, and if so, is it placed properly?

#### **excessive ice forms in the device**

- Wasn't the door open for a long time?
- Do the door seals properly adhere to the body?

### 14. Liabilities and warranties

BOLARUS S.A. markets laboratory/pharmaceutical refrigeration and freezer devices that meet safety requirements and do not endanger the safety of people, animals and property, provided that they are properly installed, maintained, kept in proper technical condition and used as intended.

The manufacturer shall affix labels on the devices to confirm their compliance with the relevant legal provisions. **CE**

The manufacturer shall guarantee the proper operation of the devices. Detailed warranty conditions are specified in the warranty card.

**The following are not covered by the warranty:**

- damage during transport (organised by the customer), loading and unloading (claims in such cases must be asserted with the company transporting the device),
- damage or malfunctions caused by incorrect and non-compliant connection and start-up (if the connection and start-up were carried out by the customer),
- damage to electrical equipment including the motor caused by a voltage drop,
- damage caused by improper operation or failure to follow the Instructions for Use,
- fuses,
- electric cells like batteries and rechargeable batteries,
- transformers.

**Repairs to the devices during the warranty period: Must be carried out by the manufacturer's authorised service centre; repairs by unauthorised persons will void the warranty;**

- Please file repair requests via the service form available at <https://www.bolarus.com.pl/serwis.html> or directly to the BOLARUS S.A. Maintenance Department (tel. 14 / 61 49 316),
- include the description of the problem, type of device, factory number and date of purchase in each request.

**To ensure the smooth and safe operation of the device:**

- use only authorised service centres,
- use only original spare parts.

## 15. Technical Data

These Instructions for Use include detailed technical specifications of the relevant device model in the form of a data sheet. Below is a table with basic technical data:

| Model   | ULTU 100        | ULTU 400        | ULTU 600        |
|---|-----------------|-----------------|-----------------|
| Line  | ULTU LINE       |                 |                 |
| Temperature range [°C]                            | -40...-86       | -40...-86       | -40...-86       |
| Max. ambient temperature [°C] / max. humidity [%] | +25/60%         | +25/60%         | +25/60%         |
| Capacity [l]:                                     | 90              | 370             | 590             |
| External dimensions LxWxH [mm]                    | 882x875x850     | 781x1007x2000   | 1061x1007x2000  |
| Internal dimensions LxWxH [mm]                    | 590x455x340     | 465x570x1320    | 745x600x1320    |
| Weight [kg]                                       | 130             | 220             | 280             |
| Insulation [mm]                                   | 120             | 120, (VIP)      | 120, (VIP)      |
| Refrigerant                                       | R290/R1150      | R290/R1150      | R290/R1150      |
| Cooling technology                                | static          | static          | static          |
| Controller type                                   | 7" touch screen | 7" touch screen | 7" touch screen |
| Display type                                      | TNT             | TNT             | TNT             |
| Power supply [V]                                  | 230             | 230             | 230             |
| Frequency [Hz]                                    | 50              | 50              | 50              |
| Power consumption [kWh/24h]                       | 13,8            | 14,7            | 15,1            |
| Power [PS]  | 3 / 4 (x2)      | 5 / 4 (x2)      | 5 / 4 (x2)      |

The above low-temperature cabinets do not contain harmful chlorofluorocarbons (CFCs) or hydrochlorofluorocarbons (HCFCs). The refrigerants they use are gases of natural origin:



propane (R290) and ethylene (R1150). These are natural agents with very low ODP (Ozone Depletion Potential) and low GWP (Global Warming Potential).

## **16. Exploded view drawings**

Below are exploded view drawings of the 3 ULTU cabinet models along with descriptions of their components.

16.1. ULTU 600 cabinet exploded view drawing

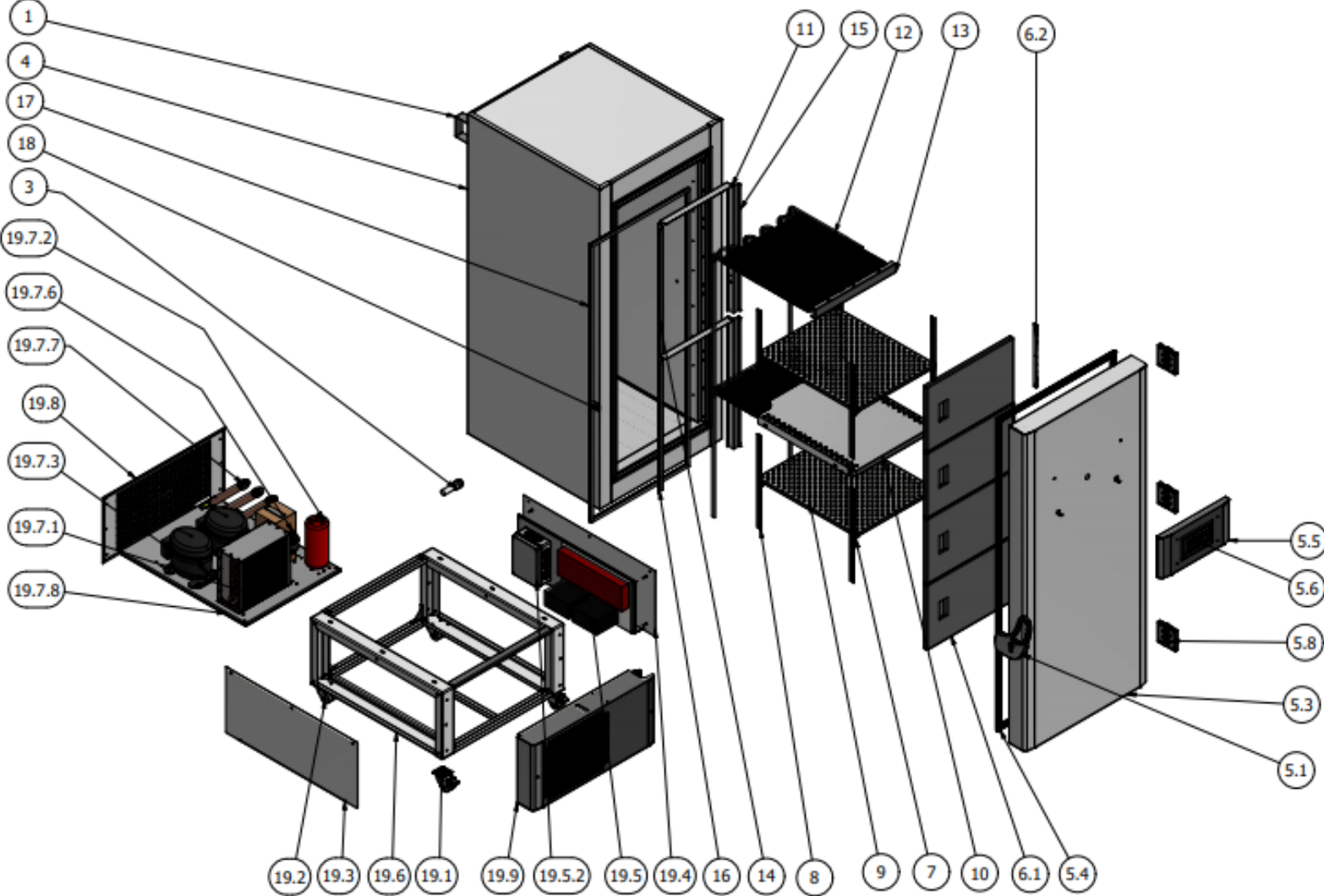

**ULTU 600 cabinet component list**

| <b>ITEM</b> | <b>QUANTITY</b> | <b>PART NUMBER</b>     | <b>DESCRIPTION</b>                           |
|-------------|-----------------|------------------------|--|
| 1           | 2               | 97-01-0032016          | Cabinet bumper                               |
| 3           | 1               | 98070500000000009901   | Decompression valve                          |
| 4           | 1               | 97-02-0012944          | Body   |
| 5.1         | 1               | 97-01-0032022          | Low-temperature door handle                  |
| 5.3         | 1               | 97-02-0012942          | Right-hand door                              |
| 5.4         | 1               | 98150101010209109901   | Door seal 678x1554                           |
| 5.5         | 1               | 97-02-0012871          | Controller cover                             |
| 5.6         | 1               | 98090102060002039901   | Controller                                   |
| 5.8         | 3               | 98460101990000000002   | ZK-041                                       |
| 6.1         | 1               | 98130100020100990002   | Right-hand inner door                        |
| 6.2         | 1               | 97-02-0012302          | Bottom inner door hinge                      |
| 7           | 8               | 98480203000000000002   | KP-F-2 shelf bracket                         |
| 8           | 8               | 98480201000000000003   | KP-E-I shelf rail                            |
| 9           | 2               | 97-01-0030307          | Perforated shelf                             |
| 10          | 1               | 97-01-0030308          | Shelf  |
| 11          | 2               | 97-01-0025273          | Evaporator angle bar                         |
| 12          | 1               | 98050409990002040301   | Shelf evaporator                             |
| 13          | 1               | 97-01-0025269          | Evaporator c-channel                         |
| 14          | 1               | 97-01-0032364          | Evaporator tube cover - short                |
| 15          | 1               | 97-01-0032363          | Evaporator tube cover - short - sensor       |
| 16          | 2               | 97-01-0032362          | Evaporator tube cover - long                 |
| 17          | 1               | 98150202010207091101   | Body silicone gasket 567x1358, height: 14 mm |
| 18          | 1               | 97-02-0013005          | Handle bracket                               |
| 19.1        | 2               | 98440101010101020101   | 50 mm double castor with brake               |
| 19.2        | 2               | 9844010101010102020101 | 50 mm double castor with no brake            |
| 19.3        | 1               | 97-01-0032024          | Cooling unit compartment side cover          |
| 19.4        | 1               | 97-02-0012948          | Cooling unit compartment side cover          |
| 19.5        | 1               | 97-02-0012949          | Electrical box base                          |
| 19.5.2      | 1               | 98250101050300000101   | Junction box 190x140x70                      |
| 19.6        | 1               | 97-02-0013106          | Cooling unit base assembly                   |
| 19.7.1      | 1               | 98040304070401000102   | Condenser                                    |
| 19.7.2      | 1               | 98999999999900000026   | Oil separator                                |
| 19.7.3      | 2               | 98020399010499000102   | COMPRESSOR                                   |
| 19.7.5      | 1               | 97-02-0013102          | Plate heat exchanger                         |
| 19.7.6      | 1               | 98110101010406000002   | Steam separator filter                       |
| 19.7.7      | 3               | 98049999000000009903   | Heat exchanger                               |
| 19.7.8      | 1               | 97-01-0032877          | Cooling unit base                            |
| 19.8        | 1               | 97-01-0032527          | Cooling unit compartment rear cover          |
| 19.9        | 1               | 97-02-0013221          | Cooling unit compartment cover - front       |

16.2. ULTU 400 cabinet exploded view drawing

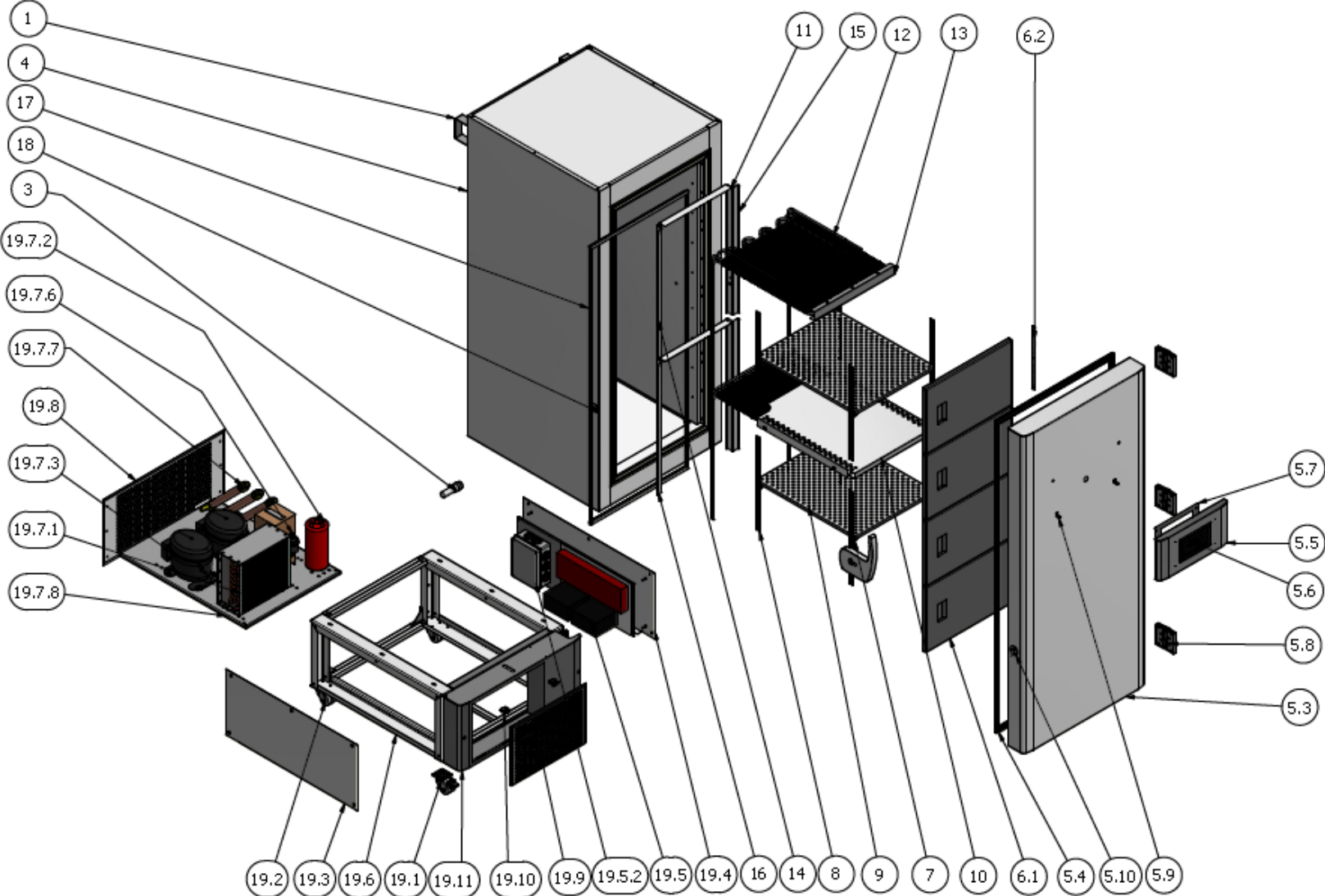

## ULTU 400 cabinet component list

| ITEM   | QUANTITY | PART NUMBER          | DESCRIPTION                                  |
|--------|----------|----------------------|--|
| 1      | 2        | 97-01-0032016        | Cabinet bumper                               |
| 3      | 1        | 98070500000000009901 | Decompression valve                          |
| 4      | 1        | 97-02-0012944        | Body   |
| 5.3    | 1        | 97-02-0012942        | Right-hand door                              |
| 5.4    | 1        | 98150101010209109901 | Door seal 678x1554                           |
| 5.5    | 1        | 97-02-0012871        | Controller cover                             |
| 5.6    | 1        | EL-PIAST controller  | Controller                                   |
| 5.7    | 1        | 97-01-0032290        | Controller lock                              |
| 5.8    | 3        | 98460101990000000002 | ZK-041                                       |
| 5.9    | 2        | 97-01-0032875        | Controller mounting angle bar                |
| 5.10   | 1        | 97-01-0032862        | Handle spacer                                |
| 5.11   | 1        | 98470199010100060101 | Handle with lock                             |
| 6.1    | 1        | 98130100020100990002 | Right-hand inner door                        |
| 6.2    | 1        | 97-02-0012302        | Bottom inner door hinge                      |
| 7      | 8        | 98480203000000000002 | Shelf bracket                                |
| 8      | 8        | 98480201000000000003 | Shelf rail                                   |
| 9      | 2        | 97-01-0030307        | Perforated shelf                             |
| 10     | 1        | 97-01-0030308        | Shelf  |
| 11     | 2        | 97-01-0025273        | Evaporator angle bar                         |
| 12     | 1        | 98050409990002040301 | Shelf evaporator                             |
| 13     | 1        | 97-01-0025269        | Evaporator c-channel                         |
| 14     | 1        | 97-01-0032364        | Evaporator tube cover - short                |
| 15     | 1        | 97-01-0032363        | Evaporator tube cover - short - sensor       |
| 16     | 2        | 97-01-0032362        | Evaporator tube cover - long                 |
| 17     | 1        | 98150202010207091101 | Body silicone gasket 567x1358, height: 14 mm |
| 18     | 1        | 97-02-0013005        | Handle bracket                               |
| 19     | 1        | 97-02-0013107        | Cooling unit base assembly                   |
| 19.1   | 2        | 984401010101020101   | 50 mm double castor with brake               |
| 19.2   | 2        | 98440101010102020101 | 50 mm double castor with no brake            |
| 19.3   | 1        | 97-01-0032024        | Cooling unit compartment side cover          |
| 19.4   | 1        | 97-02-0012948        | Cooling unit compartment side cover          |
| 19.5.1 | 1        | 97-01-0032533        | Electrical box base                          |
| 19.5.2 | 1        | 98250101050300000101 | Junction box                                 |
| 19.6   | 1        | 97-02-0013106        | Cooling unit base assembly                   |
| 19.7.1 | 1        | 98040304070401000102 | Condenser                                    |
| 19.7.2 | 1        | 98999999999900000026 | Oil separator                                |
| 19.7.3 | 2        | 98020399010499000102 | COMPRESSOR                                   |
| 19.7.4 | 1        | 97-01-0032869        | Plate heat exchanger bracket                 |
| 19.7.5 | 1        | 97-02-0013102        | Plate heat exchanger                         |
| 19.7.6 | 1        | 98110101010406000002 | Steam separator filter                       |
| 19.7.7 | 3        | 98049999000000009903 | Heat exchanger                               |
| 19.7.8 | 1        | 97-01-0032877        | Cooling unit base                            |
| 19.8   | 1        | 97-01-0032527        | Cooling unit compartment rear cover          |
| 19.9   | 1        | 97-02-0013400        | Condenser inspection window                  |
| 19.10  | 2        | 98470406010000000001 | Latch  |
| 19.11  | 1        | 97-02-0013402        | Cooling unit compartment cover - front       |

16.3. ULTU 100 cabinet exploded view drawing

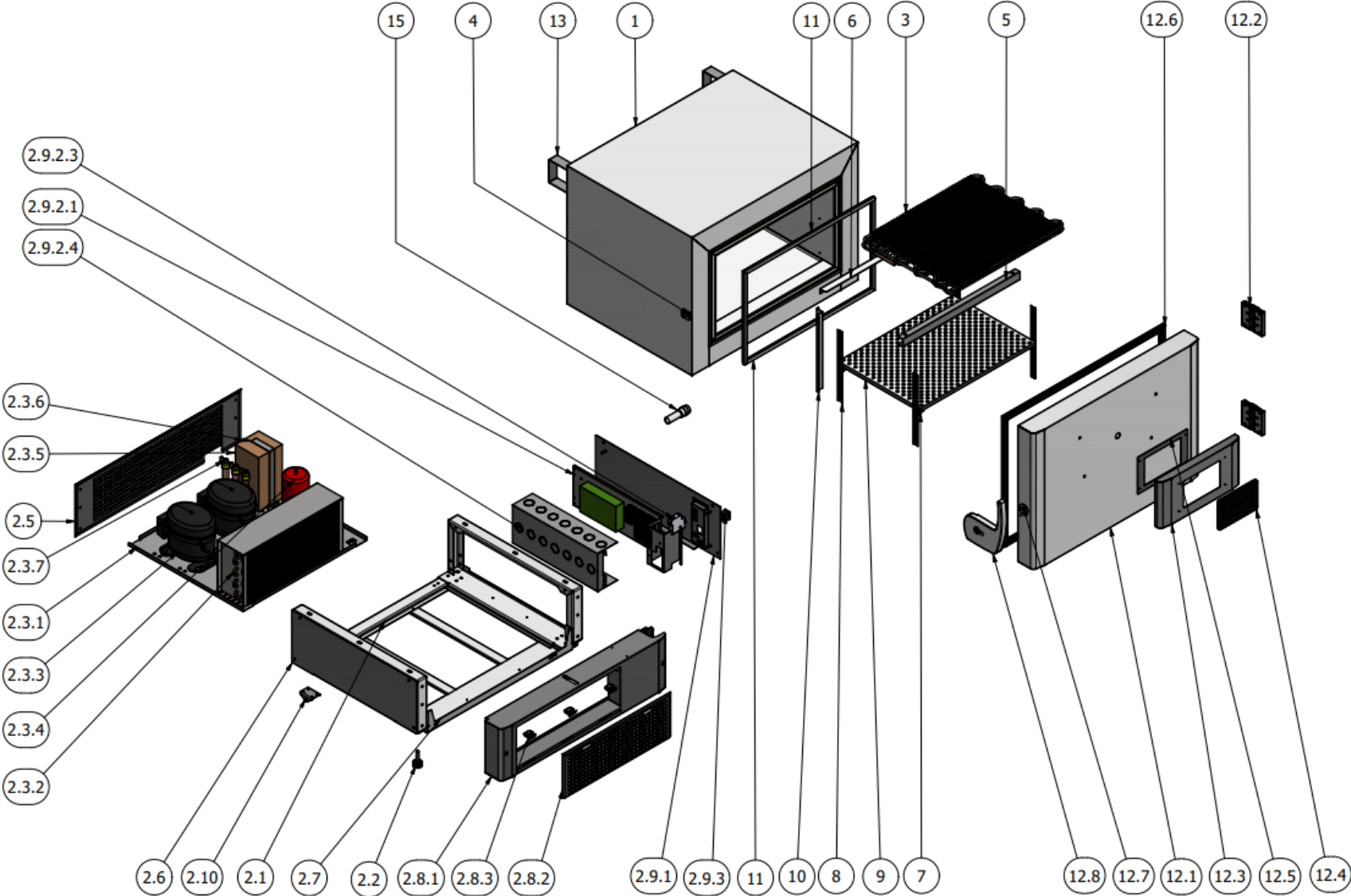

**ULTU 100 cabinet component list**

| ITEM    | QUANTITY | PART NUMBER          | DESCRIPTION                                    |
|---------|----------|----------------------|--|
| 1       | 1        | 97-02-0013019        | Body - insulation                              |
| 2.1     | 1        | 97-02-0013022        | Base - welding                                 |
| 2.2     | 2        | 98450101010201020001 | M10x40 adjustable foot                         |
| 2.3.1   | 1        | 97-01-0032702        | Cooling unit base                              |
| 2.3.2   | 1        | 9804030000000000105  | Condenser                                      |
| 2.3.3   | 2        | 98020301010601000202 | Compressor                                     |
| 2.3.4   | 1        | 98999999999900000026 | Oil separator                                  |
| 2.3.5   | 1        | 97-02-0013102        | Plate heat exchanger                           |
| 2.3.6   | 1        | 97-01-0032869        | Plate heat exchanger bracket                   |
| 2.3.7   | 3        | 98049999000000009902 | Heat exchanger                                 |
| 2.5     | 1        | 97-01-0032701        | Cooling unit compartment rear cover            |
| 2.6     | 1        | 97-01-0032699        | Base side cover                                |
| 2.7     | 1        | 97-01-0033067        | Reinforcing bar                                |
| 2.8.1   | 1        | 97-02-0013409        | Cooling unit compartment cover                 |
| 2.8.2   | 1        | 97-02-0013410        | Condenser inspection window - pressure welding |
| 2.8.3   | 3        | 98470406010000000001 | ZT-67 latch                                    |
| 2.9.1   | 1        | 97-02-0013422        | Base side cover                                |
| 2.9.2.1 | 1        | 97-01-0033692        | Electrical box base - new version              |
| 2.9.2.3 | 1        | 98260103040402000001 | 1P B10A circuit breaker                        |
| 2.9.2.4 | 1        | 97-01-0033696        | Electric equipment cover                       |
| 2.9.3   | 1        | 98260102040700000001 | Main switch WA-4.8                             |
| 2.10    | 2        | 97-02-0000051        | Roller Fi=20 folding                           |
| 3       | 1        | 98050403990001010301 | ULTU 100 evaporator                            |
| 4       | 1        | 97-02-0013005        | Handle bracket - welding                       |
| 5       | 1        | 97-01-0032694        | Evaporator c-channel                           |
| 6       | 1        | 97-01-0032698        | Evaporator angle bar                           |
| 7       | 4        | 98480203000000000002 | KP-F-2 shelf bracket                           |
| 8       | 4        | 97-01-0032711        | KP-E-I shelf rail length 305 mm                |
| 9       | 1        | 97-01-0032706        | Perforated shelf                               |
| 10      | 1        | 97-01-0032700        | Evaporator tube cover under the sensor         |
| 11      | 1        | 98150202010204051101 | Body silicone seal                             |
| 12.1    | 1        | 97-02-0013310        | Right-hand door - insulation                   |
| 12.2    | 2        | 98460101990000000002 | ZK-041   |
| 12.3    | 1        | 97-02-0012871        | Controller cover                               |
| 12.4    | 1        | Controller           | Controller                                     |
| 12.5    | 1        | 97-01-0032290        | Controller lock                                |
| 12.6    | 1        | 98150101010207080101 | Door seal                                      |
| 12.7    | 1        | 97-01-0032862        | Handle spacer                                  |
| 12.8    | 1        | 98470199010100060101 | Handle with lock - Bolarus version             |
| 13      | 2        | 97-01-0032016        | Cabinet bumper - back                          |
| 15      | 1        | 98070500000000009901 | Decompression valve                            |

## 17. ULTU 100, 400, 600 wiring diagrams

The wiring diagrams of ULTU 100, 400, 600 cabinets are presented below.

### 17.1. ULTU 100 wiring diagram

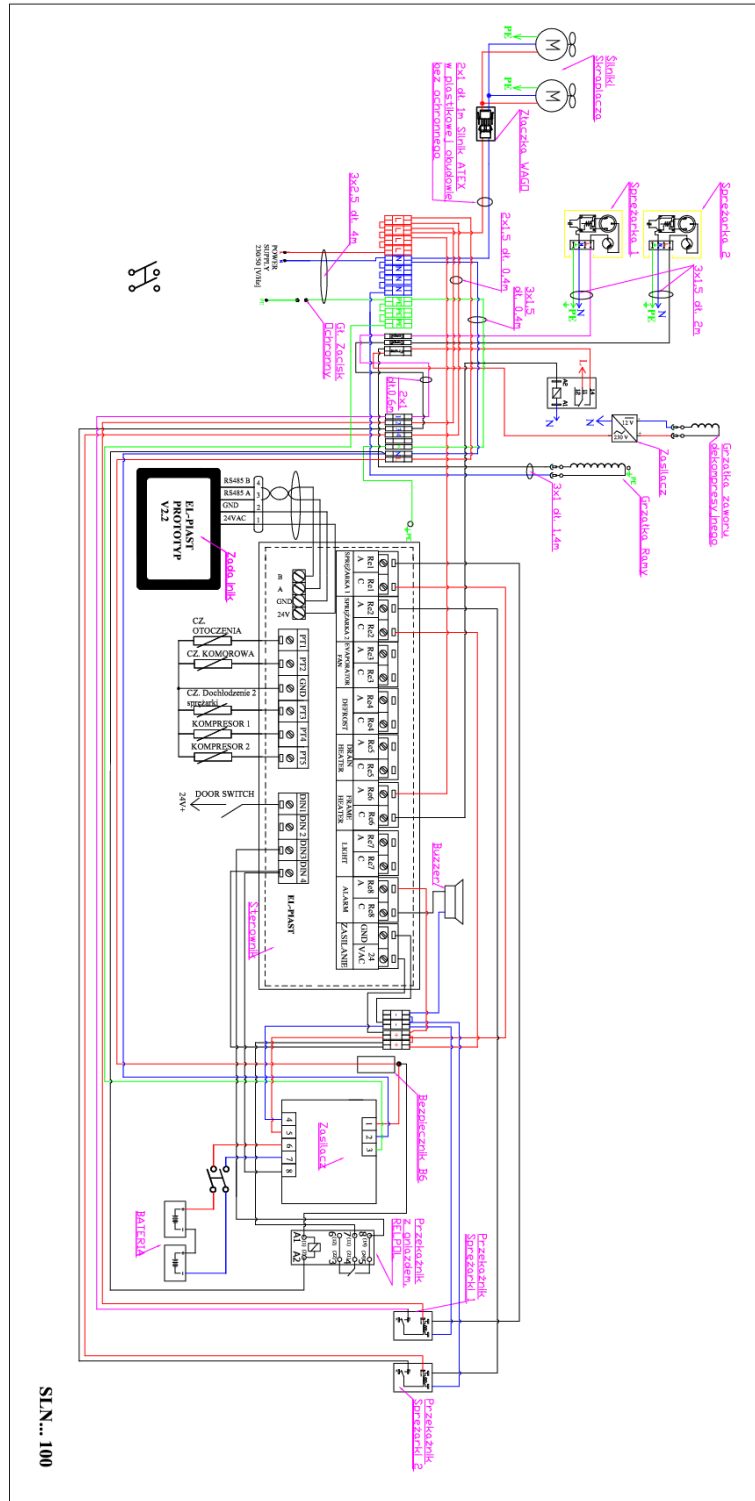



## 17.2. ULTU 400, 600 wiring diagram

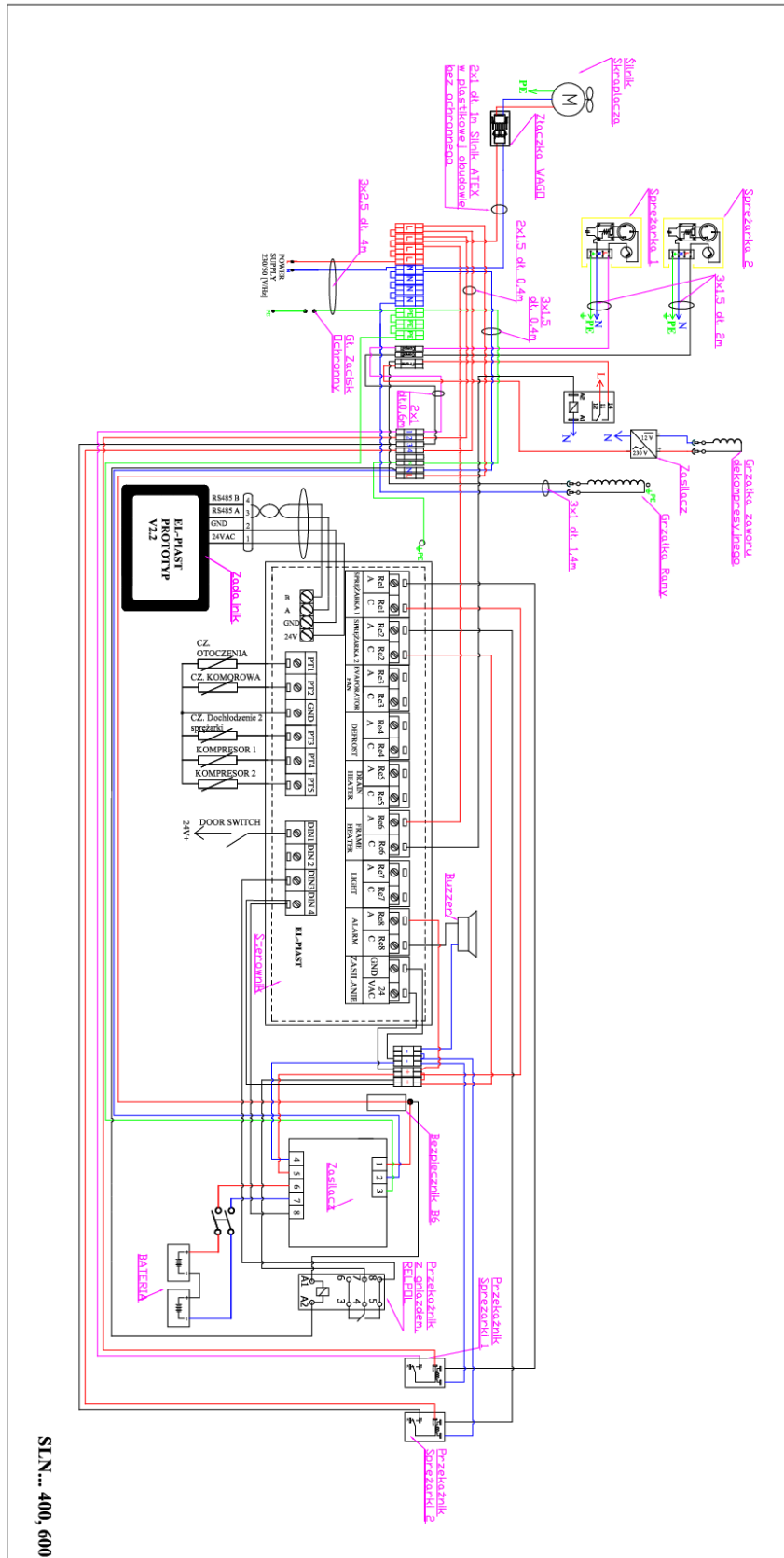



***Low-temperature cabinets are electrical devices, and at the end of their service life, they must not be stored with other waste. Please contact the manufacturer or distributor for disposal.***

|  |  |
|--|--|
| Silniki skraplacza   | Condenser motors   |
| Złączka WAGO   | WAGO connector   |
| 2x1 dł. 1m Silnik ATEX w plastikowej obudowie bez ochronnego | 2x1 length 1m ATEX motor in plastic housing without protective cover |
| Sprężarka 2  | Compressor 2   |
| 3x1,5 dł. 2m   | 3x1.5 length 2m  |
| Sprężarka 1  | Compressor 1   |
| 3x1,5 dł. 0,4 m  | 3x1.5 length 0.4m  |
| 2x1,5 dł. 0,4 m  | 2x1.5 length 0.4m  |
| 3x2,5 dł. 4 m  | 3x2.5 length 4 m   |
| Główny zacisk ochronny                                       | Main protective terminal   |
| Grzałka zaworudekompresyjnego                                | Decompression valve heater   |
| Zasilacz   | Power supply   |
| Grzałka ramy   | Frame heater   |
| 3x1 dł. 1,4 m  | 3x1 length 1.4 m   |
| Buzzer   | Buzzer   |
| Sterownik  | Controller   |
| Bezpiecznik B6   | B6 fuse  |
| Zasilacz   | Power supply   |
| Przełącznik Sprężarki 1                                      | Compressor relay 1   |
| Przełącznik z gniazdem, RELPOL                               | Relay with socket, RELPOL  |
| BATERIA  | BATTERY  |
| Przełącznik Sprężarki 2                                      | Compressor relay 2   |