



# CHEFTOP MIND.Maps™ ONE



# Index

CHEFTOP MIND.Maps™ <b>ONE</b> combi-steamers	page	<b>4</b>
Cooking Assistance	page	<b>8</b>
Technologies	page	<b>12</b>
<b>ONE</b> resistive control panel	page	<b>18</b>
CHEFTOP MIND.Maps™ <b>ONE</b> COUNTERTOP	page	<b>20</b>
CHEFTOP MIND.Maps™ <b>ONE</b> COMPACT	page	<b>26</b>
CHEFTOP MIND.Maps™ <b>ONE</b> BIG	page	<b>32</b>
CHEFTOP MIND.Maps™ <b>ONE</b> BIG COMPACT	page	<b>38</b>
Care and Maintenance	page	<b>44</b>
Technical data	page	<b>50</b>
Technical Assistance	page	<b>60</b>
Unox in the world	page	<b>62</b>

# The essence of a combi oven

CHEFTOP MIND.Maps™ ONE is the professional combi oven that allows you to obtain concrete cooking performances in a simple and intuitive way. Your experience, combined with manual functions and essential technologies, becomes fundamental. Perfectly essential, simply effective.

MIND.Maps™ ONE ovens are available in four versions, each one designed to meet the specific needs of the businesses they are made for:

**COUNTERTOP** 3, 5, 7 and 10 GN 1/1 trays for restaurants and deli corners in retail;

**COMPACT** from 5 GN 2/3 trays for professional kitchens and retail shops with limited space available for equipment;

**BIG** with 20 GN 1/1 trolley, for large kitchens;

**BIG COMPACT** with 20 GN 1/1 trolley, for large kitchens.



CHEFTOP MIND.Maps™ ONE  
COMPACT



CHEFTOP MIND.Maps™ ONE  
COUNTERTOP



CHEFTOP MIND.Maps™ ONE  
BIG



CHEFTOP MIND.Maps™ ONE  
BIG COMPACT

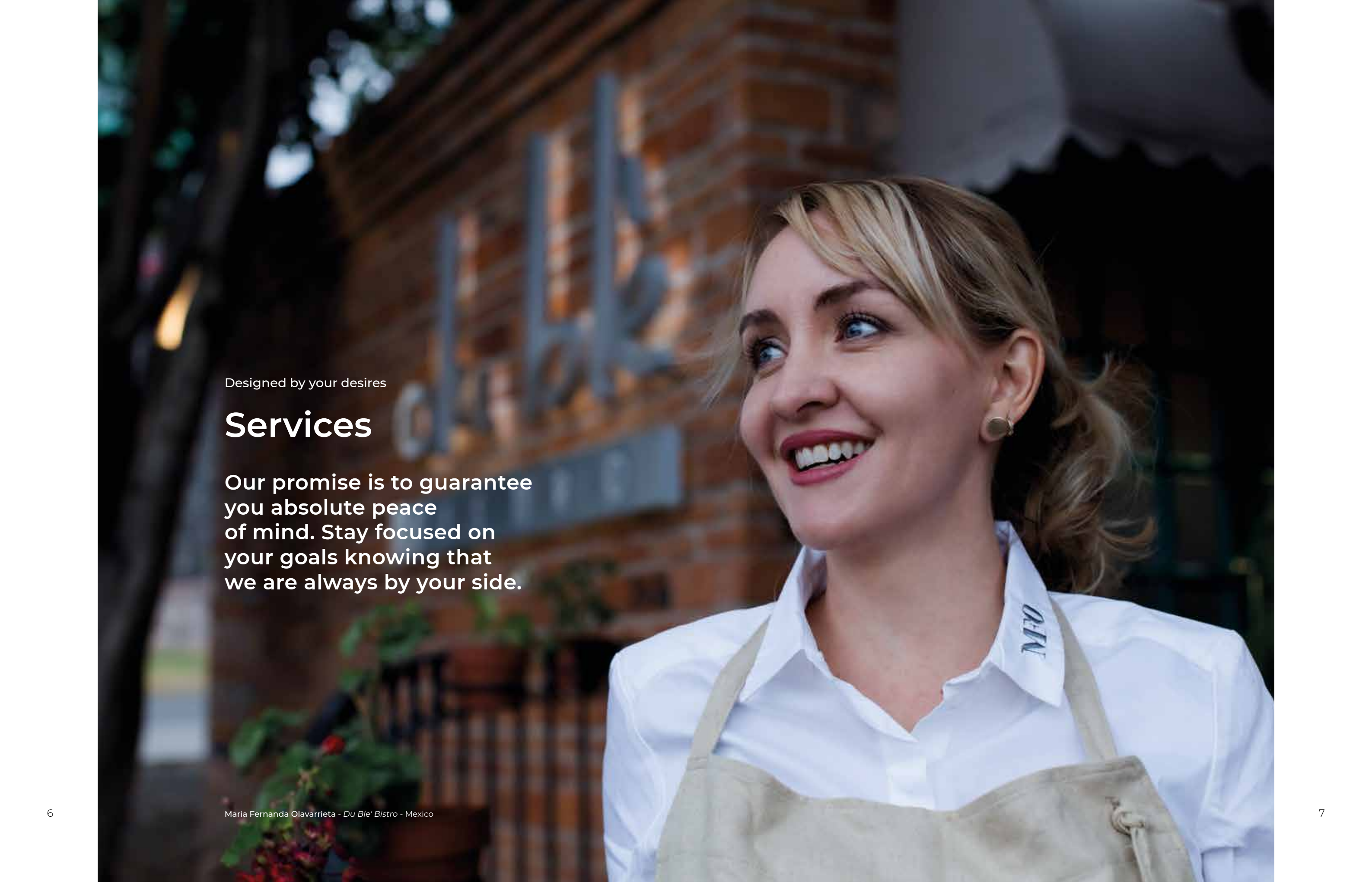

Designed by your desires

## Services

Our promise is to guarantee you absolute peace of mind. Stay focused on your goals knowing that we are always by your side.



# Try the oven for free. It's on us.

## 01

### Book

Choose when and where to try your next Unox oven. Call our customer service and set up an appointment at your convenience.

Set up an appointment, call us or book it online on [unox.com](http://unox.com)

## 02

### Cook with us

In your kitchen, with your ingredients and your recipes: a Unox Chef will make you experience all the benefits of the ovens' technologies.

## 03

### Choose

Being sure of the results you can achieve, take the time you need to make a choice based on solid certainties.



# Cooking Assistance

TOP.Training

## Discover your oven



Learn, use, improve

Top.Training is the Unox free training service. Our Chefs will show you everything you need to get the best from your new oven, from its basic features to its most advanced technologies.

Download the **Top.Training** app from Google Play or App Store

Data Driven Cooking Community

## Inspire and be inspired



A world of Recipes for your ovens

Let yourself be inspired by the DDC.App cookbook: download the recipes prepared by the Unox Chefs and by the DDC community users. Participate in the community and share your recipe!

Download **DDC.App** from Google Play or App Store

CHEF.Line

## You call, Unox answers



24/7

The Unox Chef Team is always at your disposal to give you practical advice on programs cooking methods and to suggest you new recipes: from the most traditional to the most innovative ones.

Call us  
International  
**+39 049 86 57 511**  
Oceania  
**+61 3 9876 0803**



Apple Store



Play Store



Technologies

**Easy.  
Precise.  
Effective.**

Unox Intensive Cooking

The most advanced technologies to guarantee perfect cooking, uniformity on every tray and maximum cooking intensity.

Data Driven Cooking

Artificial intelligence which allows you to monitor your oven usage and provides you with suggestions to use the ovens in a better way.

Anton Bodyashkin - Ugli Restaurant - Russia

Unox Intensive Cooking

# Maximum cooking intensity

Perfect cooking, uniformity on each tray, saturated and dense steam or complete extraction of humidity, intense or gentle air flows.

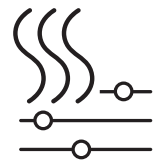

**DRY.Maxi™**

**Humidity gives way to flavour.**  
Effectively removes humidity from the cooking chamber to give your preparations perfect consistency, colour and crunchiness every time.



**STEAM.Maxi™**

**The power of steam is in your hands.**  
Generates saturated steam from 35 °C and delivers high steaming performance combined with energy and water savings.

**7 minutes**  
full load of **crunchy bacon**

**10 minutes**  
full load of **pork chops**

**26 minutes**  
full load of **steamed rice**

**28 minutes**  
full load of **steamed potatoes**

**41 minutes**  
full load of **roasted chickens**

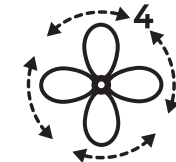

**AIR.Maxi™**

**Conducts, unites, transforms.**  
Uses multiple high flow reversing fans to deliver uniform results and short cooking times. 4 speeds of the fan allow to perform any kind of cooking.

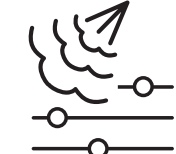

**CLIMALUX™**

**Total humidity control.**  
The oven features accurate sensors to measure the actual humidity inside the cooking chamber and automatically activates steam production or evacuation to ensure that actual humidity always matches the set one.

Focus on your customers, rely on the CHEFTOP MIND.Maps™ PLUS combi oven.  
Discover the most intelligent ovens in the world on our website [www.unox.com](http://www.unox.com)

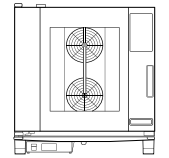





Data Driven Cooking

**Create.  
Understand.  
Improve.**

The Data Driven Cooking Artificial Intelligence transforms the consumption data of your oven into useful information that allows you to increase your daily profit.

Data will be always accessible by smartphone or PC

# An ecosystem to be discovered



## Create and share

**Your recipes in all your ovens.**  
Create your recipe book and synchronize it with all your ovens with just one click, keeping all your kitchens or stores up to date. You may create it directly from one of your ovens or from your PC.



## Understand

**Monitor and improve your performance.**  
DDC.Stats gives you full control over energy, water, and detergent consumption and over your cooking times and oven usage. Compare the performances, detect anomalies and get useful information to improve the efficiency of the ovens in your network.

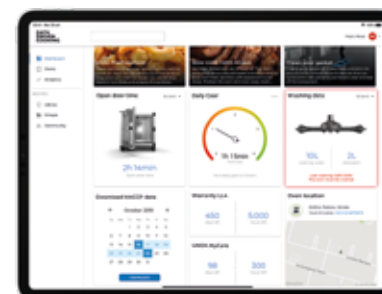

## 360° Assistance

**Let DDC.Coach train you.**  
DDC.Coach is a digital assistant that provides you with advice based on the actual use of your ovens. This allows you to take full advantage of their potential. Capitalize the abilities of your ovens and maximize the return on your investment!



ONE resistive control panel

## Easy and quick

Manual set, MIND.Maps™ programming and up to 384 cooking process memory. Set, cook, serve.

ONE control panel functions

## State of the art simplicity



### Set

**Easy, fast and crystal-clear.**

Set any cooking process in a rapid and intuitive way for each of the available cooking steps. All the settings you need in a single screen, up to 9 cooking steps. Limitless creativity.



### Programs

**384 Programs memory.**

All your recipes are unique and repeatable thanks to the personal library that allows you to store and organize your cooking programs. The oven can store 384 programs organized in 16 different groups.



### MIND.Maps™

**Do not set a cooking process, draw it.**

Add your touch of brilliance. Draw even the most elaborate cooking with a few hand gestures on the display. Design your most complex cooking processes with maximum creative freedom. You imagine, the oven executes.



CHEFTOP MIND.Maps™ ONE COUNTERTOP

## The combi oven for Foodservice

CHEFTOP MIND.Maps™ **ONE** COUNTERTOP is the point of reference for each kitchen that needs solid performances, intuitive technologies and ease of use.





Get what you wish for

# Give shape to your cooking skills

CHEFTOP MIND.Maps™ ONE COUNTERTOP is the professional combi oven that stands out for its simplicity. Nothing superfluous, nothing left to chance. Cook every dish being confident that you will always obtain the desired result.

CHEFTOP MIND.Maps™ ONE COUNTERTOP and its accessories create a unique cooking station able to cook multiple cooking processes that would otherwise require multiple pieces of specific equipment.

Easy, traditional and perfect meals. It is your experience that makes the difference; the oven guarantees you the result you desire. Simplicity translated into reliability and savings.

up to **40%**

Less energy compared to a traditional grill

up to **80%**

Less water compared to cooking in boiling water

up to **90%**

Less oil compared to a fryer



Looking for more performance?  
Discover CHEFTOP MIND.Maps™ PLUS  
on our website [www.unox.com](http://www.unox.com)

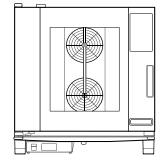

**Cooking Quality**  
Get the result  
you are looking for

**Savings**  
Energy, time  
and ingredients

**Reliability**  
Effective technology,  
solid performances



Solutions to maximize your working space

# Increase your Possibilities

Find all the possible solutions for your kitchen.  
**Configure** your CHEFTOP MIND.Maps™ ONE oven online.



Configurations



## Oven + Oven

The solution with two stacked units is ideal for maximum versatility, flexibility and energy savings.



## Oven + Neutral cabinet

Recommended solution to optimize your kitchen layout and always have everything in the right place.

Art. XWEC-0811  
Technical details at page 56



## Oven + Slowtop

Ideal oven for butchers and deli shops, that combine intense cooking processes with gentle ones, such as holding and night-time cooking.

Art. XEVSC-0711-CRM  
Technical details at page 56



## Oven + Oven + Hood

Within the ventless hood, a self-cleaning filter removes odours from the fumes that are expelled through the oven chimney.

Art. XEVH-HCT1  
Technical details at page 56

Configurations

COUNTERTOP

COUNTERTOP



CHEFTOP MIND.Maps™ ONE COMPACT

## The compact combi oven for Foodservice

CHEFTOP MIND.Maps™  
**ONE COMPACT** is the ideal  
solution for professional  
kitchens that require  
maximum simplicity  
in the smallest footprint.



Extraordinary compactness

# Concentrated power

CHEFTOP MIND.Maps™ **ONE COMPACT** is the ideal solution for professional kitchens requiring the least footprint and maximum performance.

CHEFTOP MIND.Maps™ ONE COMPACT is the combi oven with which you can easily make any type of cooking in the smallest possible space.

Cooking versatility that reaches its apex when using multi-chamber solutions that give free versatility to ever-changing menus.

## 24%

Less footprint compared to a non compact oven

## 40 kg

Maximum capacity  
2 x 2 combination \*

## 530 mm

One of the **narrowest** ovens in its category

\*Data refers to a 4 XECC-0523-EIRM ovens combination.



Looking for more performance?  
Discover CHEFTOP MIND.Maps™ **PLUS**  
on our website [www.unox.com](http://www.unox.com)

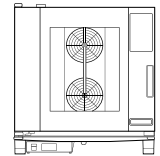

## Reduced footprint

Get the most from vertical spaces

## Flexibility

Stack 2 units to enable different cookings at the same time

## Savings

A smaller cooking chamber requires less energy

Solutions to maximize your working space

# Compact combinations

Find all the possible solutions for your kitchen.  
**Configure** your CHEFTOP MIND.Maps™ ONE oven online.

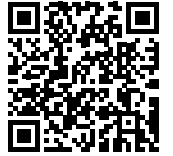

## The benefits of 4 cooking chambers in the footprint of 2.

A restaurant is made of variable rhythms; turn on just the ovens you need, reducing energy consumption, or turn all of them on for maximum flexibility.

Configurations

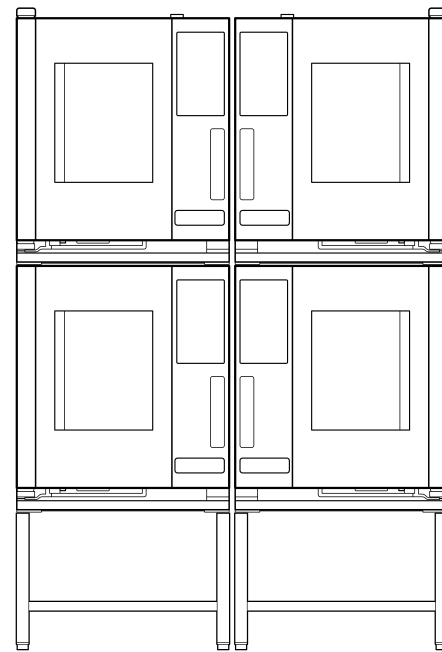
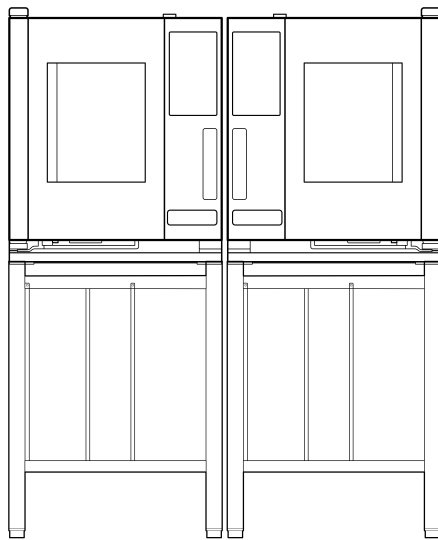

Same space, double capacity.

Discover CHEFTOP MIND.Maps™ PLUS COMPACT GN 1/1 version on our website [www.unox.com](http://www.unox.com)

COMPACT  
30



1 m

Configurations

COMPACT  
31



CHEFTOP MIND.Maps™ ONE BIG

## The combi oven for Large Kitchens

The CHEFTOP MIND.Maps™ ONE BIG trolley oven is the ideal tool for large kitchens, which need simple technology, cooking quality and high productivity.





What matters to you

# The essence of food production

CHEFTOP MIND.Maps™ ONE BIG is the professional trolley oven which allows you to make large quantities of cookings in a simple and intuitive way.

CHEFTOP MIND.Maps™ ONE BIG features simplified technology designed to give concrete support to your work.

Grilling, browning, traditional cooking and much more: high performances that meet the needs of those professionals who look for practicality and reliability.

**90 kg**

Full load maximum capacity

**260 °C**

Maximum cooking temperature

**6.5 mins**

Preheating time from 30 °C to 260 °C

Data refer to XEVL-2011-EIRS model



Exceed your limits.

Find out on [www.unox.com](http://www.unox.com) the limitless performances of CHEFTOP MIND.Maps™ PLUS BIG, with its 6 reverse gear fans and vertical heating elements.

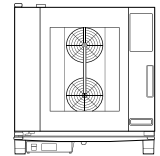

**Productivity**  
High volumes,  
zero stops

**Quality**  
Get the results  
you are looking for

**Reliability**  
Effective technology,  
solid performances



Solutions that maximise your return on investment

# Practicality and speed at your service

Find all the possible solutions for your kitchen.  
**Configure** your CHEFTOP MIND.Maps™ ONE oven online.



CHEFTOP MIND.Maps™ BIG ONE ovens are the ideal solution for all common cooking tasks in cooking centres and large kitchens looking for reliability, certainty of results and a quick return on investment.



2,8 m

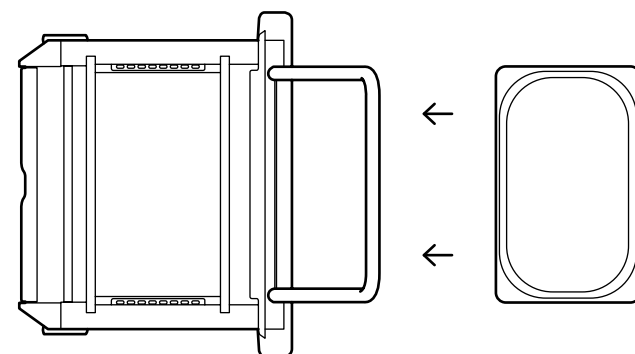

## Tray insertion from the long side

Better visibility of all the food in the oven, even when fully loaded.

Do you need a solution that is compatible with GN1/2 and GN1/3 trays? Discover CHEFTOP MIND.Maps™ BIG COMPACT at page 42

## QUICK.Load

20 GN 1/1 trolleys for fast insertion in the oven and easy transport of full loads.

Art. XEVTL-2011  
Technical details at page 57

## QUICK.Plate

A trolley to regenerate up to 51 plates in a few minutes. We are at your disposal to customize your QUICK.Plate based on your specific needs.

Art. XEVTL-051P  
Technical details at page 57

## HOLDING.Cover

Holding cover keeps the regenerated plates at the right temperature before serving.

Art. XUC030  
Technical details at page 57





CHEFTOP MIND.Maps™ ONE BIG COMPACT

## Compact outside, big inside

CHEFTOP MIND.Maps™ **ONE** BIG COMPACT professional trolley oven is the ideal tool for large kitchens, that need simple technology, to maximise productivity and space.



Small spaces, big productions

# The essence of production without space limits

CHEFTOP MIND.Maps™ **ONE BIG COMPACT** is the professional trolley oven which allows you to maximise the productivity per square meter in a simple and intuitive way.

CHEFTOP MIND.Maps™ **ONE BIG COMPACT** concentrates an extraordinary simple technology in 650 mm width to give you maximum performance in minimum space.

Grilling, browning, traditional cooking and much more: high productions that meet the professional needs of those who prefer practicality of use and reliability.

**90 kg**

Full load **maximum capacity**

**260 °C**

Maximum **cooking temperature**

**6.5 min**

**Preheating time**  
from 30 °C to 260 °C



**Reduced footprint**  
Maximum productivity  
in just 0,65 square  
metres

**Compatibility**  
The trolley is compatible  
with the majority  
of blast chillers

**Reliability**  
Effective technology,  
solid performances

Solutions that maximise the productivity per square metre

# Small spaces, big productions

The benefits of 4 ovens  
in the footprint of 3

Find all the possible solutions  
for your kitchen.  
**Configure** your  
CHEFTOP MIND.Maps™ ONE oven online.



Solutions



2,8 m

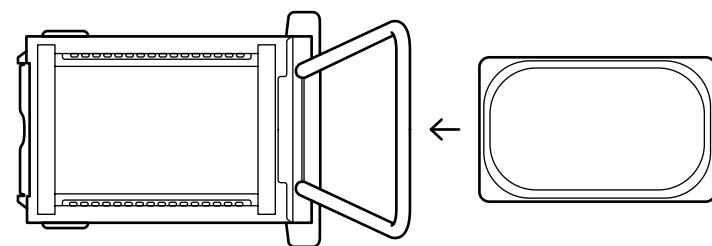

## Compatible with GN1/1, GN1/2 and GN1/3 trays

Compact design achieved by  
inserting the tray from the  
short side.

Do you need a solution with tray  
insertion from the long side?  
Discover CHEFTOP MIND.Maps™ BIG  
at page 36.



## QUICK.Load

20 GN 1/1 trolleys  
for fast insertion in the oven  
and easy transport of  
full loads.

Art. XECTL-2013  
Technical details at page 57

## QUICK.Plate

A trolley to regenerate up to  
51 plates in a few minutes.  
We are at your disposal to  
customize your QUICK.Plate  
based on your specific needs.

Art. XECTL-051P  
Technical details at page 57

## HOLDING.Cover

Holding cover keeps  
the regenerated plates  
at the right temperature  
before serving.

Art. XUC033  
Technical details at page 57

Solutions

BIG COMPACT

BIG COMPACT





Discover SENSE.Klean,  
the technology that reduces  
the consumption of water, detergent  
and energy.

Available only for  
CHEFTOP MIND.Maps™ PLUS ovens.

Take care of your oven

## Care and maintenance

Press a button and select  
the washing mode that  
is more suitable for the  
actual degree of dirt.  
While the oven washes,  
focus on what counts  
for your kitchen.

# UNOX.Pure

# DET&Rinse™

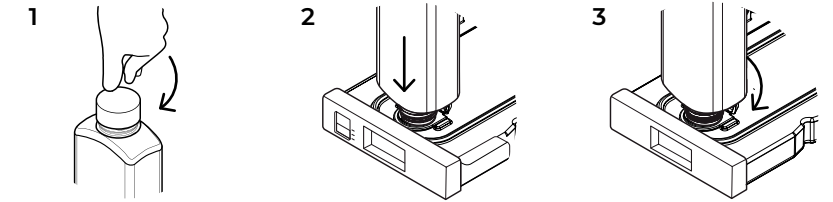

Care and Maintenance



## PURE-RO

Reverse osmosis system that reduces the carbonate hardness of water to zero, thus avoiding any scale deposits inside the oven.

Art. XHC002  
Technical details at page 56

Not required for CHEFTOP MIND.Maps™ BIG ovens.



## PURE

The UNOX.Pure filter reduces the carbonate hardness in water, thus avoiding scale deposits inside the oven cooking chamber.

Art. XHC003  
Technical details at page 56



## REFILL

Replacement cartridge for UNOX.Pure.

Art. XHC004  
Technical details at page 56



## PLUS

Cleaning and rinse agents to combine maximum cleanliness with minimum consumption and long life for your oven.

Art. DB1015  
Technical details at page 56



## ECO

Eco formula for daily cleaning and the utmost respect for the environment. Ideal for mild level of dirt.

Art. DB1018  
Technical details at page 56



## ULTRA

Ultra strong detergent for high level of dirt, recommended for poultry and meat fats.

Art. DB1050\*  
Technical details at page 56

\*Check the product availability for your Country.

Care and Maintenance

MIND.Maps™ ONE



Discover all the ovens and their combined accessories

# The essence of a combi oven

# CHEFTOP MIND.Maps™ ONE

## COUNTERTOP

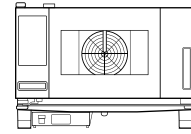

750 x 783 x 538 mm  
w x d x h

### ⚡ XEVC - 0311 - EIRM

capacity 3 GN 1/1  
pitch 67 mm  
frequency 50/60 Hz  
voltage 380-415V 3N~  
power 5 kW  
weight 54 kg

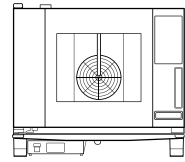

750 x 783 x 675 mm  
w x d x h

### ⚡ XEVC - 0511 - EIRM

capacity 5 GN 1/1  
pitch 67 mm  
frequency 50/60 Hz  
voltage 380-415V 3N~  
power 9,3 kW  
weight 66 kg

### ⚡ XEVC - 0511 - EIRM - LP

low power version  
power 7 kW

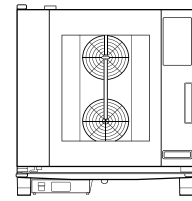

750 x 783 x 843 mm  
w x d x h

### ⚡ XEVC - 0711 - EIRM

capacity 7 GN 1/1  
pitch 67 mm  
frequency 50/60 Hz  
voltage 380-415V 3N~  
power 11,7 kW  
weight 82 kg

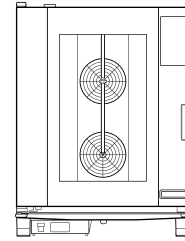

750 x 783 x 1010 mm  
w x d x h

### ⚡ XEVC - 1011 - EIRM

capacity 10 GN 1/1  
pitch 67 mm  
frequency 50/60 Hz  
voltage 380-415V 3N~  
power 18,5 kW  
weight 92 kg

## COMPACT

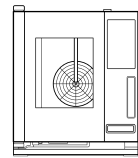

535 x 672 x 649 mm  
w x d x h

### ⚡ XECC - 0523 - EIRM

capacity 5 GN 2/3  
pitch 67 mm  
frequency 50/60 Hz  
voltage 380-415V 3N~  
power 5,15 kW  
weight 56 kg

## BIG

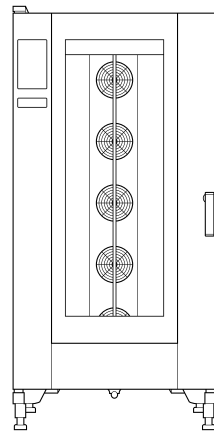

892 x 925 x 1875 mm  
w x d x h

### ⚡ XEVL - 2011 - EIRS

capacity 20 GN 1/1  
pitch 67 mm  
frequency 50/60 Hz  
voltage 380-415V 3N~  
power 35,5 kW  
weight 262 kg

## BIG COMPACT

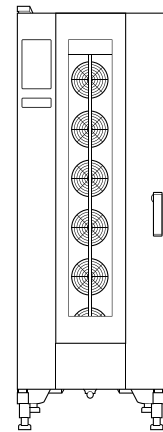

650 x 1002 x 1875 mm  
l x p x h

### ⚡ XECL - 2013 - EIRS

capacity 20 GN 1/1  
pitch 67 mm  
frequency 50/60 Hz  
voltage 380-415V 3N~  
power 35,5 kW  
weight 285 kg

# Features

- Standard
- Optional
- Not available

BIG and BIG COMPACT  
COUNTERTOP and COMPACT

### UNOX INTELLIGENT PERFORMANCE

ADAPTIVE.Cooking™: automatically regulates the baking parameters to ensure repeatable results	—	—
CLIMALUX™: total control of the humidity in the baking chamber	●	●
SMART.Preheating: sets automatically the temperature and the duration of the preheating	—	—
AUTO.Soft: manages the heat rise to make it more delicate	—	—
SENSE.Klean: estimates how dirty the oven is and suggests appropriate automatic cleaning	—	—

### UNOX INTENSIVE COOKING

DRY.Maxi™: rapidly extracts the humidity from the baking chamber	●	●
STEAM.Maxi™: produces saturated steam starting from 35 °C	●	●
AIR.Maxi™: multiple fans with reverse gear and 4 speed settings	●	●
EFFICIENT.Power: ENERGY STAR certified energy efficiency	—	—
PRESSURE.Steam: increases the saturation and temperature of steam	—	—

### DATA DRIVEN COOKING

Wi-Fi connection	○	○
Ethernet connection	○	○
ddc.unox.com: control the oven usage in real time, create and send recipes from your PC to your ovens	●	●
DDC.Stats: analyse, compare and improve the user and consumption data of your oven	—	—
DDC.App: monitor all connected ovens in real time from your smartphone	●	●
DDC.Coach: analyses the way in which you use the oven and suggests personalised recipes	●	●

### MANUAL BAKING

Convection baking from 30 °C to 260 °C	●	●
Convection baking from 30 °C to 300 °C	—	—
Mixed convection + steam baking starting from 35 °C with STEAM.Maxi™ from 30% to 90%	●	●
Convection + humidity baking starting from 48 °C with STEAM.Maxi™ from 10% to 20%	●	●
Saturated steam baking starting from 48 °C to 130 °C with STEAM.Maxi™ 100%	●	●
Convection baking + forced humidity extraction from 30 °C with DRY.Maxi™ from 10% to 100%	●	●
baking with core probe and DELTA T function	●	●
Single-point core probe	●	●
MULTI.Point core probe	—	—
SOUS-VIDE core probe	○	○

### ADVANCED AND AUTOMATIC BAKING

MIND.Maps™: draw the baking processes directly on the display	●	●
PROGRAMS: up to 384 programmes that can be saved with name, picture or handwritten signature	●	●
CHEFUNOX: choose something to cook from the library and the oven will automatically set all the parameters	—	—
MULTI.Time: manages up to 10 baking processes at the same time	—	—
MISE.EN.PLACE: synchronises the insertion of pans so that all the dishes are ready at the same time	—	—

### AUTOMATIC CLEANING

Rotor.KLEAN™: 4 automatic cleaning programmes	●	●
Rotor.KLEAN™: water and detergent level detector	—	—
Integrated DET&Rinse™ detergent container	●	●

### AUXILIARY FUNCTIONS

Preheating up to 300 °C can be set by the user for each programme	—	—
Preheating up to 260 °C can be set by the user for each programme	●	●
Remaining baking time display	●	●
Holding baking mode "HOLD" and continuous functioning "INF"	●	●
Display of the nominal value of the baking parameters	●	●
Temperature units in °C or °F	●	●

### PERFORMANCE AND SAFETY

Protek.SAFE™: automatic fan stop on opening the door	●	●
Protek.SAFE™: power modulation of electricity or gas depending on actual need	—	—
Spido.GAS™: high-performance straight heat exchanger pipes for symmetrical heat distribution	—	—
Spido.GAS™: high-performance pressure burners and symmetrical exchangers	—	—

### TECHNICAL DETAILS

Baking chamber in high-resistance AISI 304 stainless steel with rounded edges	—	●
Moulded baking chamber in AISI 316 L marine stainless steel	●	—
Baking chamber with C-shaped rack rails	●	●
Baking chamber lighting through LED lights embedded in the door	●	●
9.5" touchscreen capacitive control panel	—	—
7" touchscreen resistive control panel	●	●
Control panel with water resistance certification - IPX5	●	●
Drip collection system integrated in the door and functional even with the door open	●	●
Heavy-duty structure with the use of innovative materials	●	●
4-speed multiple fan system and high-performance circular resistance	—	●
6 motors with multiple fan system with reverse gear and high power intensity rectilinear resistance	—	—
Door hinges made of high-resistance, self-lubricating techno-polymer	●	●
Door stop positions 120° - 180°	●	—
Door stop positions 60° - 120° - 180°	—	●
Reversible door in use even after installation	—	○
Door thickness 70 mm	●	—
Detachable internal glass door for ease of cleaning	●	●
Two-stage safety door opening / closure	●	○
Proximity door contact switch	●	●
Self-diagnosis system to detect problems or breakdowns	●	●
Safety temperature switch	●	●

Notes  
All ovens have an optional model with a left to right door opening - item code example XEVC-1011-E1LM.  
All BIG ovens have the trolley included.





# Technical details



Anti condensation drip tray



Wi-Fi connection

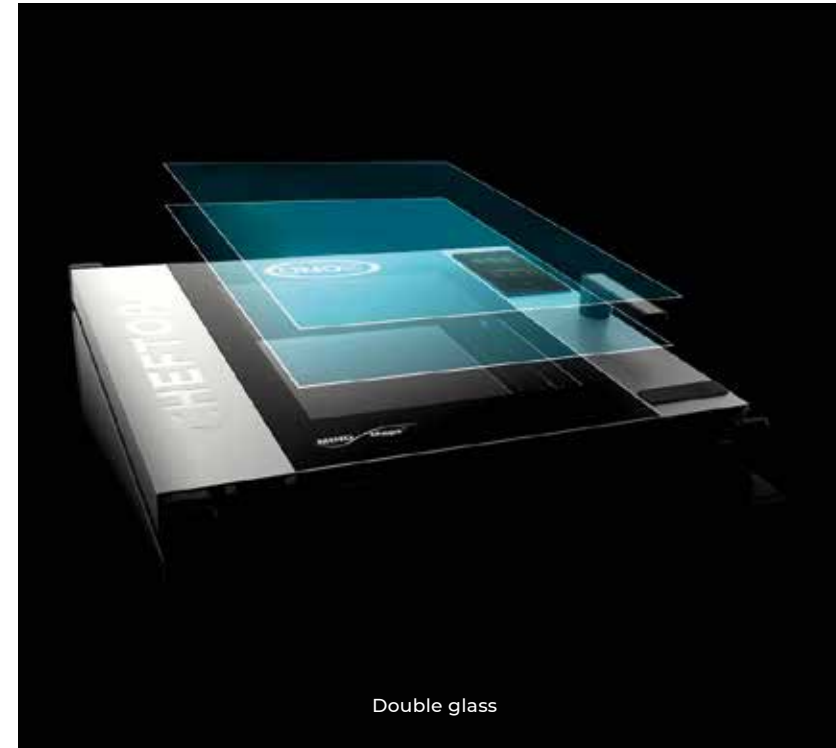

Double glass



Integrated DET&Rinse™ tank



MULTI.point and SOUS Vide core probe

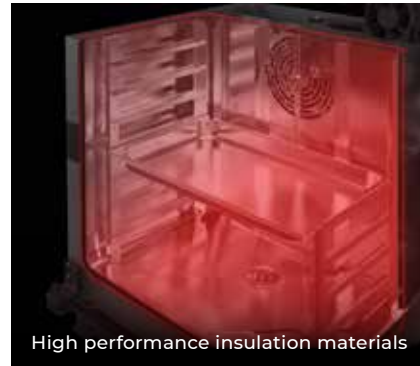

High performance insulation materials



Integrated LED light



Stainless steel AISI 304 cooking chamber

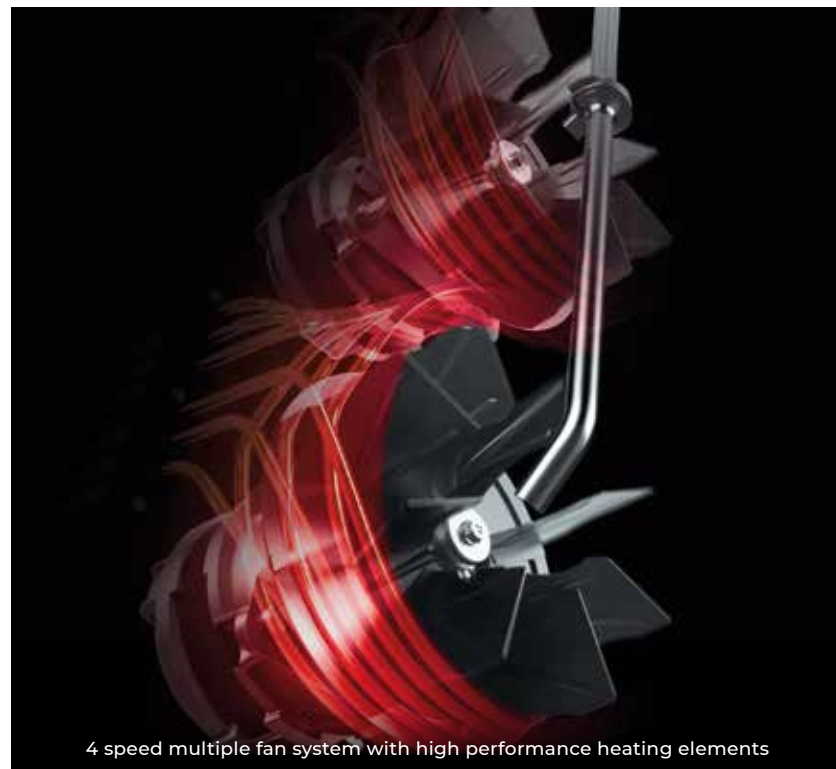

4 speed multiple fan system with high performance heating elements



USB port for upload/download of data



Door docking position at 60°/120°/180°



Ergonomic handle

# Technical details

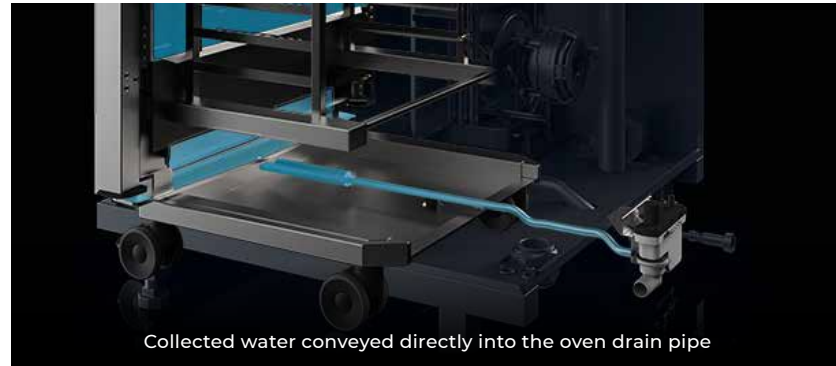

Collected water conveyed directly into the oven drain pipe



Wi-Fi connection



Cooking chamber made of highly corrosion-resistant AISI 316L steel



Space-frame chassis made of 50 mm thick stainless steel tubes



USB port for upload/download of data



MULTI.point and SOUS Vide core probe

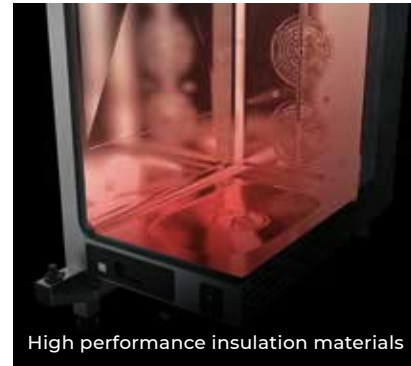

High performance insulation materials



Integrated LED light

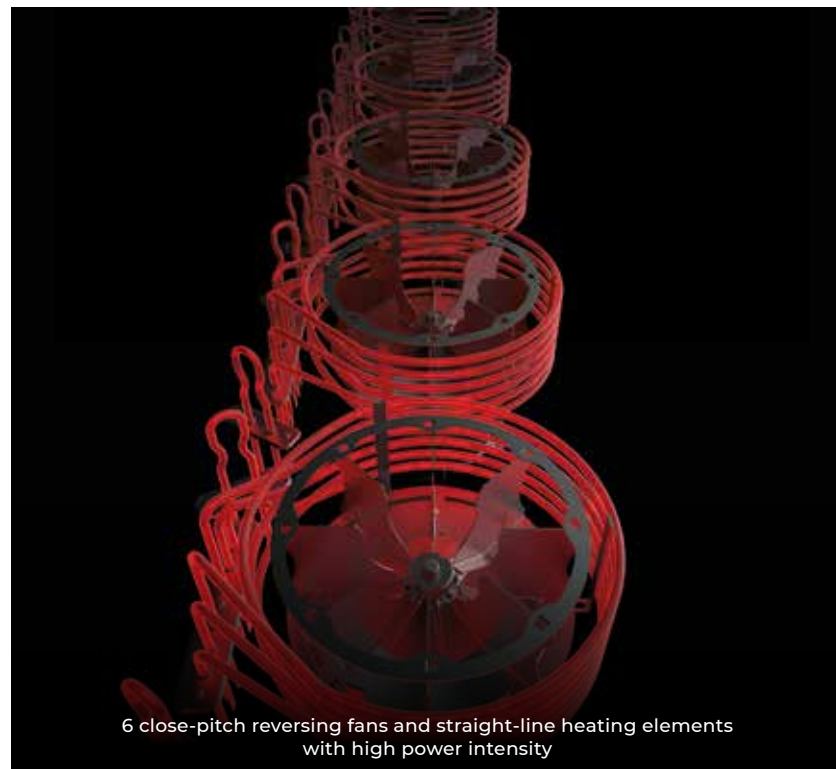

6 close-pitch reversing fans and straight-line heating elements with high power intensity



Push-to-close system with safety latch.

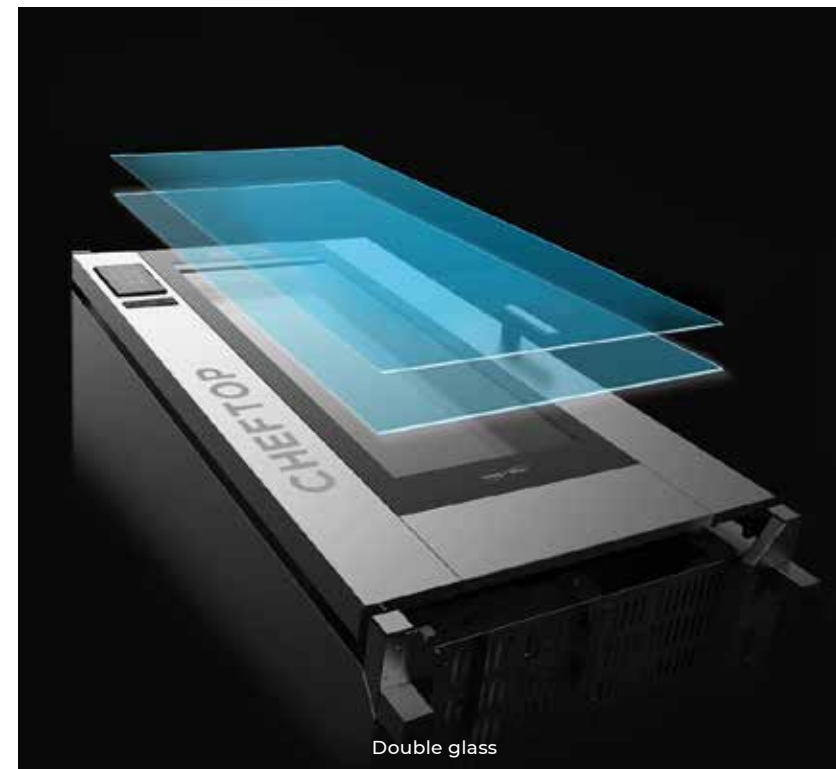

Double glass

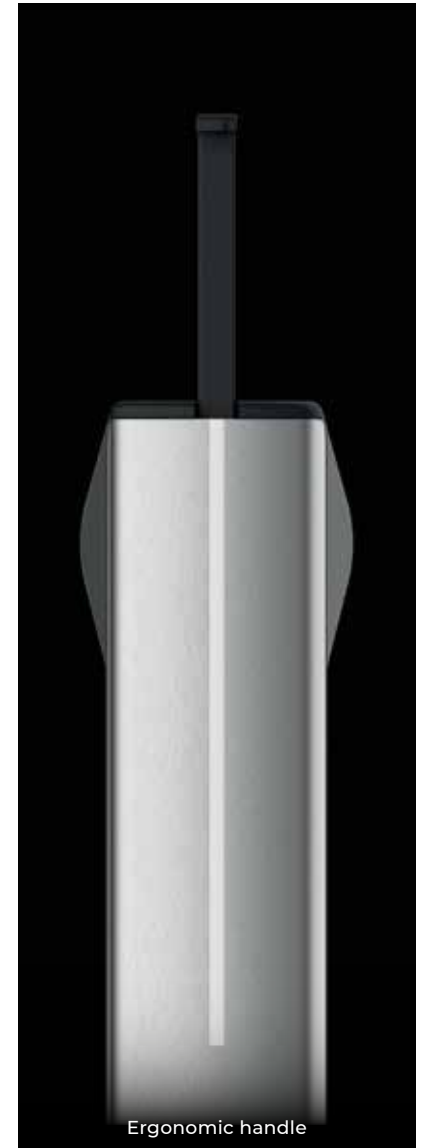

Ergonomic handle



# Accessories

Discover all the available accessories on our website



## SLOWTOP

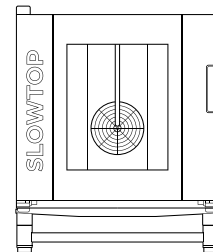

### SLOWTOP

for GN 1/1 COUNTERTOP ovens  
750 x 792 x 961 mm - w x d x h  
Art. XEVSC-0711-CRM

## HOODS

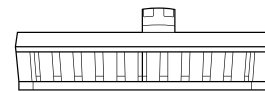

### HOOD WITH STEAM CONDENSER

for GN 1/1 BIG ovens  
892 x 1131 x 342 mm - w x d x h  
Art. XEAHL-HCFL

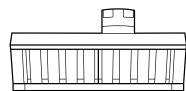

### HOOD WITH STEAM CONDENSER

for GN 1/1 COUNTERTOP ovens  
750 x 956 x 240 mm - w x d x h  
Art. XEVHC-HC11

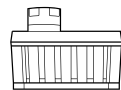

### HOOD WITH STEAM CONDENSER

for GN 2/3 COMPACT ovens  
535 x 900 x 240 mm - w x d x h  
Art. XEHC-HC23

## NEUTRAL CABINET

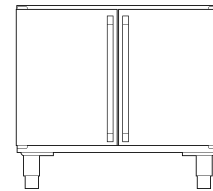

### NEUTRAL CABINET

for GN 1/1 COUNTERTOP ovens  
750 x 656 x 676 mm - w x d x h  
Art. XWVEC-0811

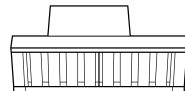

### HOOD WITH ACTIVATED CARBON FILTER

for GN 1/1 COUNTERTOP ovens  
750 x 956 x 366 mm - w x d x h  
Art. XEVHC-CF11

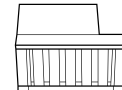

### HOOD WITH ACTIVATED CARBON FILTER

for GN 2/3 COMPACT ovens  
535 x 823 x 366 mm - w x d x h  
Art. XEHC-CF23

## STAND

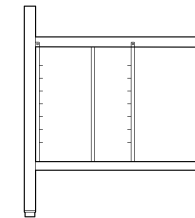

### ULTRA HIGH STAND

for GN 1/1 COUNTERTOP ovens  
732 x 641 x 888 mm - w x d x h  
Art. XWVRC-0711-UH

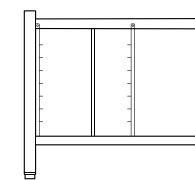

### HIGH STAND

for GN 1/1 COUNTERTOP ovens  
732 x 546 x 752 mm - w x d x h  
Art.: XWVRC-0711-H

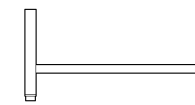

### INTERMEDIATE STAND

for GN 1/1 COUNTERTOP ovens  
732 x 546 x 462 mm - w x d x h  
Art. XWVRC-0011-M



### LOW STAND

for GN 1/1 COUNTERTOP ovens  
732 x 546 x 305 mm - w x d x h  
Art. XWVRC-0011-L

for GN 2/3 COMPACT ovens  
518 x 484 x 305 mm - w x d x h  
Art. XWCRC-0023-L

## BASKETS AND TROLLEYS

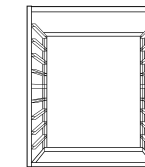

### BASKET

for 10 GN 1/1 COUNTERTOP ovens  
568 x 361 x 713 mm - w x d x h  
Art. XWVBC-0911

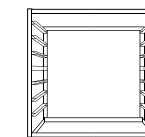

### BASKET

for 7 GN 1/1 COUNTERTOP ovens  
568 x 361 x 546 mm - w x d x h  
Art. XWVBC-0611

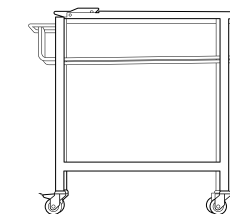

### TROLLEY

for basket GN 1/1  
605 x 700 x 923 mm - w x d x h  
Art. XWVYC-0011

## CARE AND MAINTENANCE

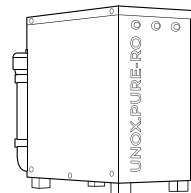

### UNOX.PURE-RO

reverse osmosis filtering system  
230 x 540 x 445 mm - w x d x h  
Art. XHC002

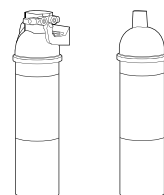

### UNOX.PURE

water treatment with resin filters  
Art. XHC003  
+ REFILL FILTER CARTRIDGE  
Art. XHC004

## CLEANING AGENTS



### DET&RINSE™ PLUS DET&RINSE™ ECO DET&RINSE™ ULTRA

one box contains 10 x 1 lt tanks  
Art. DB1015  
Art. DB1018  
Art. DB1050

## CONNECTION



### ACCESSORIES FOR THE OVENS CONNECTIONS

Wi-Fi connection kit for COUNTERTOP ovens  
Art. XEC002  
Wi-Fi connection kit for BIG ovens  
Art. XEC016

## FLOOR POSITIONING

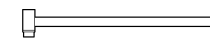

\*Mandatory for oven positioning on the floor

### FLOOR POSITIONING

for GN 1/1 COUNTERTOP ovens  
732 x 546 x 113 mm - w x d x h  
Art. XWVRC-0011-F

## QUICK.LOAD & QUICK.PLATE

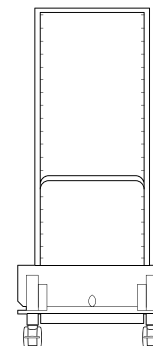

### QUICK.LOAD

for BIG ovens  
776 x 681 x 1741 mm - w x d x h  
Art. XEVTL-2011

for BIG COMPACT ovens  
520 x 668 x 1745 mm - w x d x h  
Art. XECTL-2013

### QUICK.PLATE

for BIG ovens - 51 plates  
776 x 681 x 1709 mm - w x d x h  
Art. XEVTL-051P

for BIG COMPACT ovens - 51 plates  
520 x 668 x 1711 mm - w x d x h  
Art. XECTL-051P

## KIT RUOTE

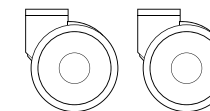

### WHEELS KIT

2 wheels with brake - 2 wheels without brake - safety chains  
Art. XUC012

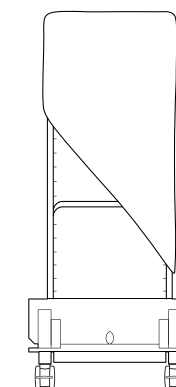

### HOLDING.COVER

holding cover  
for QUICK.LOAD e QUICK.PLATE GN 1/1  
Art. XUC030  
for QUICK.LOAD e QUICK.PLATE GN 1/1 BIG COMPACT  
Art. XUC033

## COOKING ESSENTIALS

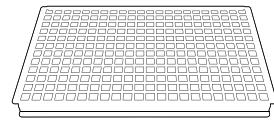

### GRILL

Non-stick aluminium pan for grilling - tray preheating is not necessary

GN 1/1 h 37 mm  
**Art. TG885**  
GN 2/3 h 37 mm  
**Art. TG720**

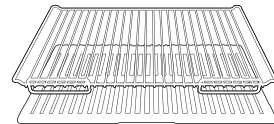

### SUPER.GRILL

Ribbed non-stick aluminium pan for grilling, includes GRP970 - with quick load system, to quickly insert full loads

GN 1/1 h 40 mm  
**Art. TG970**

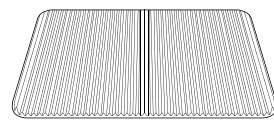

### FAKIRO.GRILL

Non-stick aluminium pan with two surfaces - flat and ribbed - for different cookings

GN 1/1 h 12 mm  
**Art. TG870**  
GN 2/3 h 12 mm  
**Art. TG770**

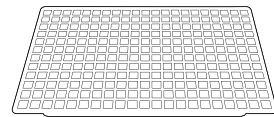

### BACON.GRID

Perforated stainless steel pan

GN 1/1 h 13,5 mm  
**Art. TG944**

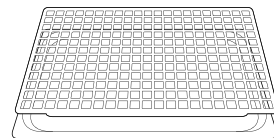

### BACON.20

Stainless steel pan with fat collection system

GN 1/1 h 21 mm  
**Art. TG840**

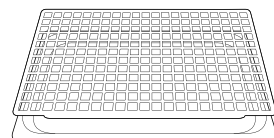

### BACON.40

Stainless steel pan with fat collection system

GN 1/1 h 41 mm  
**Art. TG945**

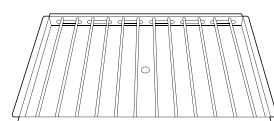

### POLLO.GRILL

Stainless steel tray for roasting meat and fish with fat collection system and central drainage

GN 1/1 h 27 mm  
**Art. GRP840**



### STEEL.20

Stainless steel pan

GN 1/1 h 20 mm  
**Art. TG805**  
**STEEL.40**  
GN 1/1 h 40 mm  
**Art. TG815**

GN 2/3 h 40 mm  
**Art. TG705**

### STEEL.65

GN 1/1 h 65 mm  
**Art. TG825**

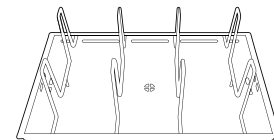

### POLLO.BLACK

Non-stick stainless steel tray with vertical supports for 8 or 4 whole chickens - with fat collection system and central drainage

GN 1/1 h 167 mm  
**Art. GRP825**  
GN 2/3 h 140 mm  
**Art. GRP715**



### BLACK.20

Non-stick stainless steel pan

GN 1/1 h 20 mm  
**Art. TG895**



### BLACK.40

Non-stick stainless steel pan

GN 1/1 h 40 mm  
**Art. TG900**

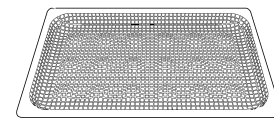

### BLACK.FRY

Perforated stainless steel pan for frying

GN 1/1 h 40 mm  
**Art. GRP816**

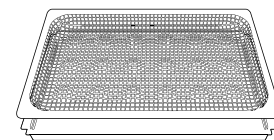

### CLEAN.FRY

Perforated non-stick stainless steel pan for frying - with fat collection system

GN 1/1 h 51,5 mm  
**Art. GRP820**

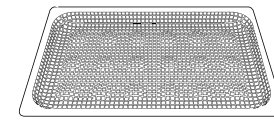

### POTATO.FRY

Perforated stainless steel pan for French fries

GN 1/1 h 40 mm  
**Art. GRP817**  
GN 2/3 h 30 mm  
**Art. GRP711**



### PAN.FRY

Non-stick stainless steel pan for frying

GN 1/1 h 20 mm  
**Art. TG905**  
GN 2/3 h 20 mm  
**Art. TG735**

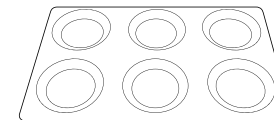

### EGGS 6 x 2

Non-stick aluminium tray for frying up to 12 eggs

GN 1/1 h 27 mm  
**Art. TG935**

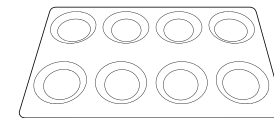

### EGGS 8 x 1

Non-stick aluminium tray for frying up to 8 eggs

GN 1/1 h 27 mm  
**Art. TG936**  
GN 2/3 h 27 mm  
**Art. TG937**

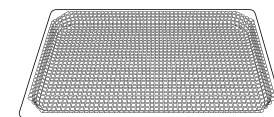

### STEAM

Perforated stainless steel pan for steaming

GN 1/1 h 40 mm  
**Art. GRP815**  
GN 2/3 h 30 mm  
**Art. GRP710**

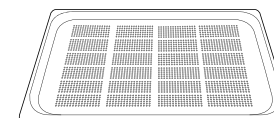

### FORO.STEEL20

Stainless steel pan

GN 1/1 h 20 mm  
**Art. TG810**

### FORO.STEEL 40

GN 1/1 h 40 mm  
**Art. TG820**

GN 2/3 h 40 mm  
**Art. TG710**

### FORO.STEEL 65

GN 1/1 h 65 mm  
**Art. TG830**

## BAKING ESSENTIALS

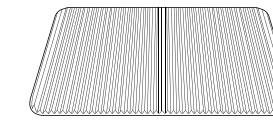

### FAKIRO™

Non-stick aluminium pan with two surfaces - flat and ribbed - for different products

GN 1/1 h 12 mm  
**Art. TG875**  
GN 2/3 h 37 mm  
**Art. TG715**

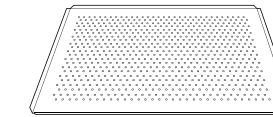

### FORO.BLACK

Perforated non-stick aluminium pan

GN 1/1 h 15 mm  
**Art. TG890**  
GN 2/3 h 15 mm  
**Art. TG730**

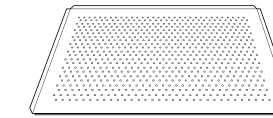

### FORO.SILICO

Perforated silicon coated aluminium pan for bakery and pastry products

GN 1/1 h 12 mm  
**Art. TG975**

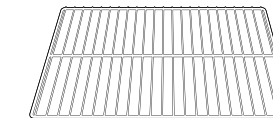

### CHROMO.GRID

Stainless steel grid

GN 1/1 h 8,5 mm  
**Art. GRP806**  
GN 2/3 h 8,5 mm  
**Art. GRP705**



# Technical Assistance

## Installation

### The right partner next to your kitchen

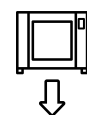

#### A global Service network

A perfect installation is essential to guarantee the correct functioning of your MIND.Maps™ ONE oven and eliminate interruptions in your daily work. We focus on you, so you can focus on what matters to you. Find the authorized Service Centers nearest to your kitchen.

## Maintenance

### Don't stop your kitchen



#### The quickest on site Service

When connected to the internet, your oven communicates directly with our Service Team, so we can intervene as soon or even before maintenance is required. Keeping in optimal condition your oven is Unox' priority: our technicians are at your disposal to provide you the best on-line and on-site support.

## LONG.Life and LONG.Life4 Warranty

### A promise of reliability



#### A choice made to last

Connect your CHEFTOP MIND.Maps™ ONE to the internet and activate the UNOX LONG.Life4 extended warranty on our website unox.com. Up to 4 years / 10.000 working hours, whichever occurs first, on parts and 2 years on labor.\*

\*Check the Guarantee Conditions for your country on our website unox.com

## **LONG**Life4!

Global Company. Best Services worldwide.

# UNOX in the world

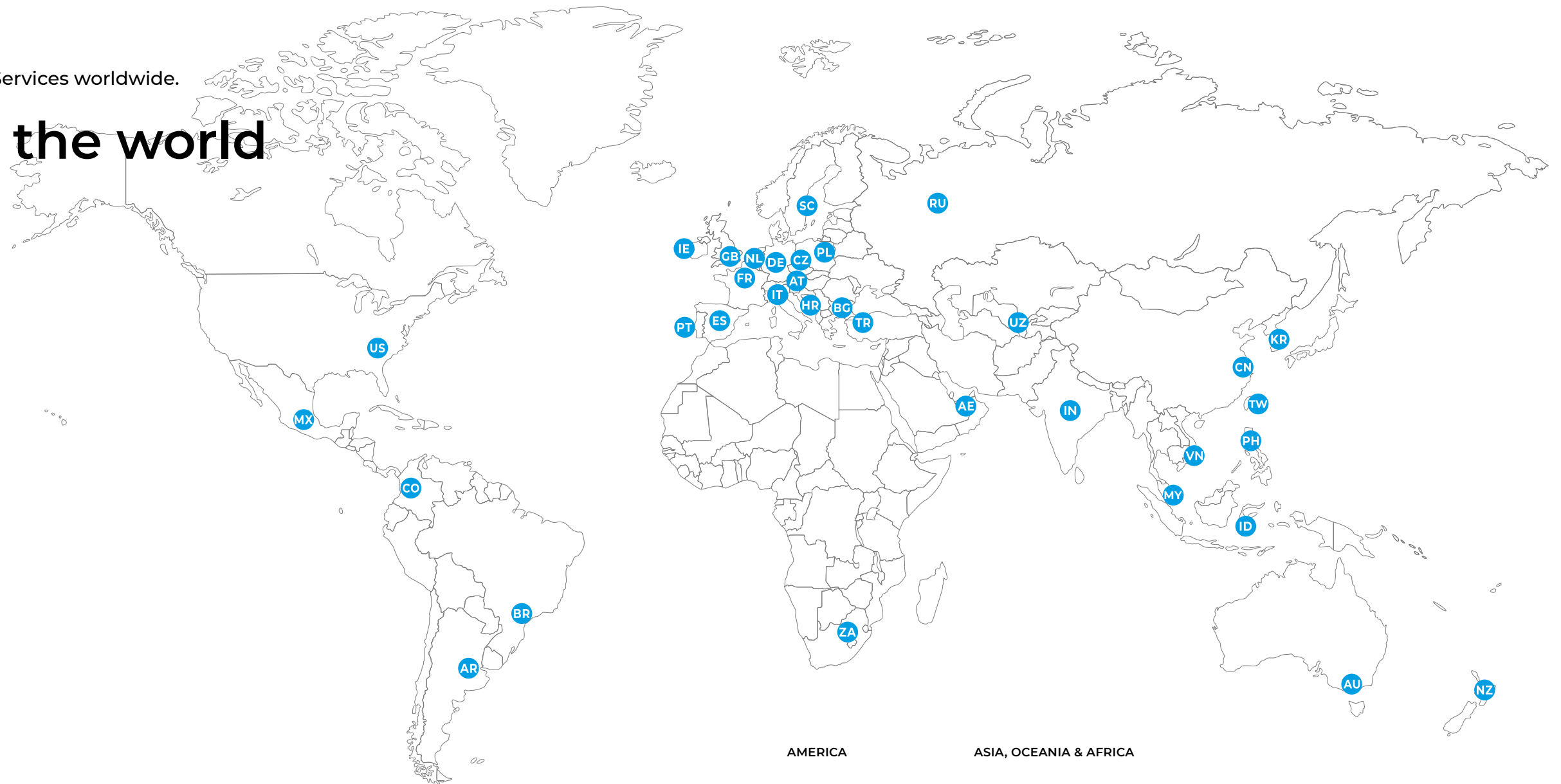

Contacts

## INTERNAZIONALE

**UNOX S.p.a**  
Via Majorana, 22  
35010 - Cadoneghe (PD) - Italy  
E-mail: info@unox.com  
Tel: +39 049 8657511

## EUROPE

**IT - ITALIA**  
UNOX S.p.a  
E-mail: info@unox.it  
Tel: +39 049 736 0781

**DE - DEUTSCHLAND**  
UNOX DEUTSCHLAND GMBH  
E-mail: info.de@unox.com  
Tel: +49 32 211121581

**FR - FRANCE, BELGIUM & LUXEMBOURG**  
UNOX FRANCE s.a.s.  
E-mail: info.fr@unox.com  
Tel: +33 4 81 68 19 12

**PT - PORTUGAL**  
UNOX PORTUGAL  
E-mail: info.pt@unox.com  
Tel: +351 918 228 787

**ES - ESPAÑA**  
UNOX PROFESIONAL ESPAÑA S.L.  
E-mail: info.es@unox.com  
Tel: +34 932 20 36 52

**GB - UNITED KINGDOM**  
UNOX UK Ltd.  
E-mail: info.uk@unox.com  
Tel: +44 1252 851 522

**IE - IRELAND**  
UNOX IRELAND  
E-mail: info.ie@unox.com  
Tel: +353 (0) 87 32 23 218

**SC - SCANDINAVIAN COUNTRIES**  
UNOX SCANDINAVIA AB  
E-mail: info.se@unox.com  
Tel: +46(0)790 75 63 64

**AT - ÖSTERREICH**  
UNOX ÖSTERREICH GMBH  
E-mail: info.de@unox.com  
Tel: +43 1206 092 068

**RU - РОССИЯ, ПРИБАЛТИКА И СТРАНЫ СНГ**  
UNOX РОССИЯ  
E-mail: info.ru@unox.com  
Tel: +7 (499) 702 - 00 - 14

**CZ - ČESKÁ REPUBLIKA**  
UNOX DISTRIBUTION s.r.o.  
E-mail: info.cz@unox.com  
Tel: +420 241 940 000

**HR - HRVATSKA**  
UNOX CROATIA  
E-mail: narudzbe@unox.com  
Tel: +39 049 86 57 538

**BG - БЪЛГАРИЯ**  
UNOX BULGARIA  
E-mail: info.bg@unox.com  
Tel: +359 2 419 05 00

**PL - POLSKA**  
Unox Polska Sp.zo.o.  
E-mail: info.pl@unox.com  
Tel: + 48 22 104 17 01

**TR - TÜRKİYE - UNOX TURKEY**  
Profesyonel mutfak ekipmanlari endüstri ve ticaret limited şirketi  
E-mail: info.tr@unox.com  
Tel: +90 530 176 62 03

**NL - NETHERLANDS**  
UNOX NETHERLANDS B.V.  
E-mail: info.nl@unox.com  
Tel: +31 70 700 6170

## AMERICA

**US - U.S.A. & CANADA**  
UNOX Inc.  
E-mail: info.usa@unox.com  
Tel: +1 800 489 8669

**CO - COLOMBIA**  
UNOX COLOMBIA  
E-mail: info.co@unox.com  
Tel: +57 350 65 88 204

**BR - BRASIL**  
UNOX BRASIL SERVICOS LTDA.  
E-mail: info.br@unox.com  
Tel: +55 11 98717-8201

**AR - ARGENTINA**  
UNOX ARGENTINA  
E-mail: info.ar@unox.com  
Tel: +54 911 37 58 43 46

**MX - MEXICO**  
UNOX MEXICO, S. DE R.L. DE C.V.  
E-mail: info.mx@unox.com  
Tel: +52 55 8116-7720

## ASIA, OCEANIA & AFRICA

**ZA - SOUTH AFRICA**  
UNOX SOUTH AFRICA  
E-mail: info.za@unox.com  
Tel: +27 845 05 52 35

**AE - U.A.E.**  
UNOX MIDDLE EAST DMCC  
E-mail: info.uae@unox.com  
Tel: +971 4 554 2146

**UZ - UZBEKISTAN**  
UNOX PRO LLC  
E-mail: info.uz@unox.com  
Tel: +998 90 370 90 10

**CN - 中华人民共和国**  
UNOX TRADING(SHANGHAI) Ltd. CO.  
E-mail: info.china@unox.com  
Tel: +86 21 56907696

**MY - MALAYSIA & SINGAPORE**  
UNOX (ASIA) SDN. BHD  
E-mail: info.asia@unox.com  
Tel: +603-58797700

**PH - PHILIPPINES**  
UNOX PHILIPPINES  
E-mail: Order.Asia@unox.com  
Tel: +63 9173108084

**ID - INDONESIA**  
UNOX INDONESIA  
E-mail: Order.Asia@unox.com  
Tel: +62 81908852999

**KR - 대한민국**  
UNOX KOREA CO. Ltd.  
E-mail: info.kr@unox.com  
Tel: +82 2 69410351

**TW - TAIWAN, HONG KONG & MACAU**  
UNOX TAIWAN  
E-mail: info.tw@unox.com  
Tel: +886 928 250 536

**AC - OTHER ASIAN COUNTRIES**  
UNOX (ASIA) SDN. BHD  
E-mail: info.asia@unox.com  
Tel: +603-58797700

**AU - AUSTRALIA**  
UNOX AUSTRALIA PTY Ltd.  
E-mail: info@unoxaustralia.com.au  
Tel: +61 3 9876 0803

**NZ - NEW ZEALAND**  
UNOX NEW ZEALAND Ltd.  
E-mail: info@unox.co.nz  
Tel: +64 (0) 800 76 0803

**IN - INDIA**  
UNOX INDIA PRIVATE LIMITED  
E-mail: info.in@unox.com  
Tel: +971 4 554 2146

**VN - VIETNAM**  
UNOX INDOCHINA  
E-mail: info.asia@unox.com  
Tel: +84916560803

Contacts

MIND.Maps™ ONE

MIND.Maps™ ONE





INVENTIVE SIMPLIFICATION

[unox.com](http://unox.com)



LI1396B1 printed 11-2021

All images used are for illustrative purposes only.

All features indicated in this catalogue may be subject to change and could be updated without notice.